

Unique pools

Hotel & Spa | 2023

by  ROSA
GRES



04

Proyectos
Projects
Projets

78

Servicios
Services
Services

82

Seguridad
Security
Sécurité

84

Nuevo pavimento drenante
New draining pavement
Nouvelle chaussée drainante

90

Colores
Colors
Couleurs

98

Sistemas constructivos, piezas especiales
Construction systems, trim pieces
Systèmes de construction, pièces spéciales

116

Cocina industrial
Industrial kitchen
Cuisine industrielle

120

Sostenibilidad
Sustainability
Durabilité

123

Características técnicas
Technical characteristics
Caractéristiques techniques

Dar la vuelta al mundo con nuestro gres porcelánico es uno de los retos más motivadores que existen. Los colores Rosa Gres han viajado a hoteles de todos los continentes.

El secreto es soñarlo y trabajar inspirados para estar ahí. Con un equipo increíble preparado para crear proyectos únicos. Acompañando a cada cliente con verdadera ilusión y el espíritu de partner que nos identifica como empresa.

En este catálogo descubriréis una selección de nuestros proyectos de Hotel más emblemáticos. Os mostramos nuestras soluciones constructivas, colores y texturas. Todas pensadas para crear detalles únicos, confort y la máxima seguridad para vuestros huéspedes.

Deseamos inspirarte y te invitamos a confiar en nuestro equipo. La calidad, la resistencia, la funcionalidad, la creatividad y la sostenibilidad son los valores que guían la creación de todos nuestros productos y soluciones.

En Rosa Gres ecodiseñamos todos nuestros productos y sistemas constructivos para reducir su impacto ambiental.

Nos encantará compartir contigo lo que hemos aprendido a lo largo de más de 50 años explorando nuevos proyectos en todo el mundo. Porque sabemos, como tú, que cada Hotel es una experiencia única, un Hotel único.

Gracias por estar aquí.

Traveling around the world with our porcelain stoneware is one of the most motivating challenges of all. The Rosa Gres colors have traveled to hotels on every continent.

The secret is to dream and to work with the inspiration that comes from being there. With an incredible team willing to create unique projects. Guiding each client with true enthusiasm and the spirit of partnership that distinguishes us as a company.

In this catalog, you will discover a selection of our most emblematic hotel projects. We present our constructive solutions, colors and textures. All designed to create unique features, comfort and maximum safety for your guests.

We want to inspire you and invite you to place your trust in our team. Quality, durability, functionality, creativity and sustainability are the values that guide the creation of each and every one of our products and solutions.

At Rosa Gres we ecodesign all our products and construction systems in a way that reduces their environmental impact.

We cannot wait to share with you the things we have learned over the course of 50 years of exploring new projects all over the world. Because, like you, we know that every Hotel is a unique experience, a unique Hotel.

Thank you for being here.

Parcourir le monde avec notre grès cérame est l'un des défis les plus motivants qui soit. Les couleurs de Rosa Gres ont voyagé dans les hôtels de tous les continents.

Le secret est d'en rêver et de travailler avec inspiration pour y arriver. Avec une équipe incroyable prête à créer des projets uniques. Accompagner chaque client avec un véritable enthousiasme et l'esprit de partenariat qui nous identifie en tant qu'entreprise.

Dans ce catalogue, vous découvrirez une sélection de nos projets hôteliers les plus emblématiques. Nous vous présentons nos solutions de construction, nos couleurs et nos textures. Tous ces éléments sont conçus pour créer des détails uniques, un confort et une sécurité maximale pour vos hôtes.

Nous voulons vous inspirer et vous inviter à faire confiance à notre équipe. Qualité, solidité, fonctionnalité, créativité et durabilité sont les valeurs qui guident la création de tous nos produits et solutions.

Chez Rosa Gres, tous nos produits et systèmes de construction sont éco-conçus afin de réduire leur impact sur l'environnement.

Nous sommes heureux de partager avec vous ce que nous avons appris au cours de plus de 50 ans d'exploration de nouveaux projets dans le monde entier. Parce que nous savons, comme vous, que chaque hôtel est une expérience unique, un hôtel unique.

Nous vous remercions d'être là.





















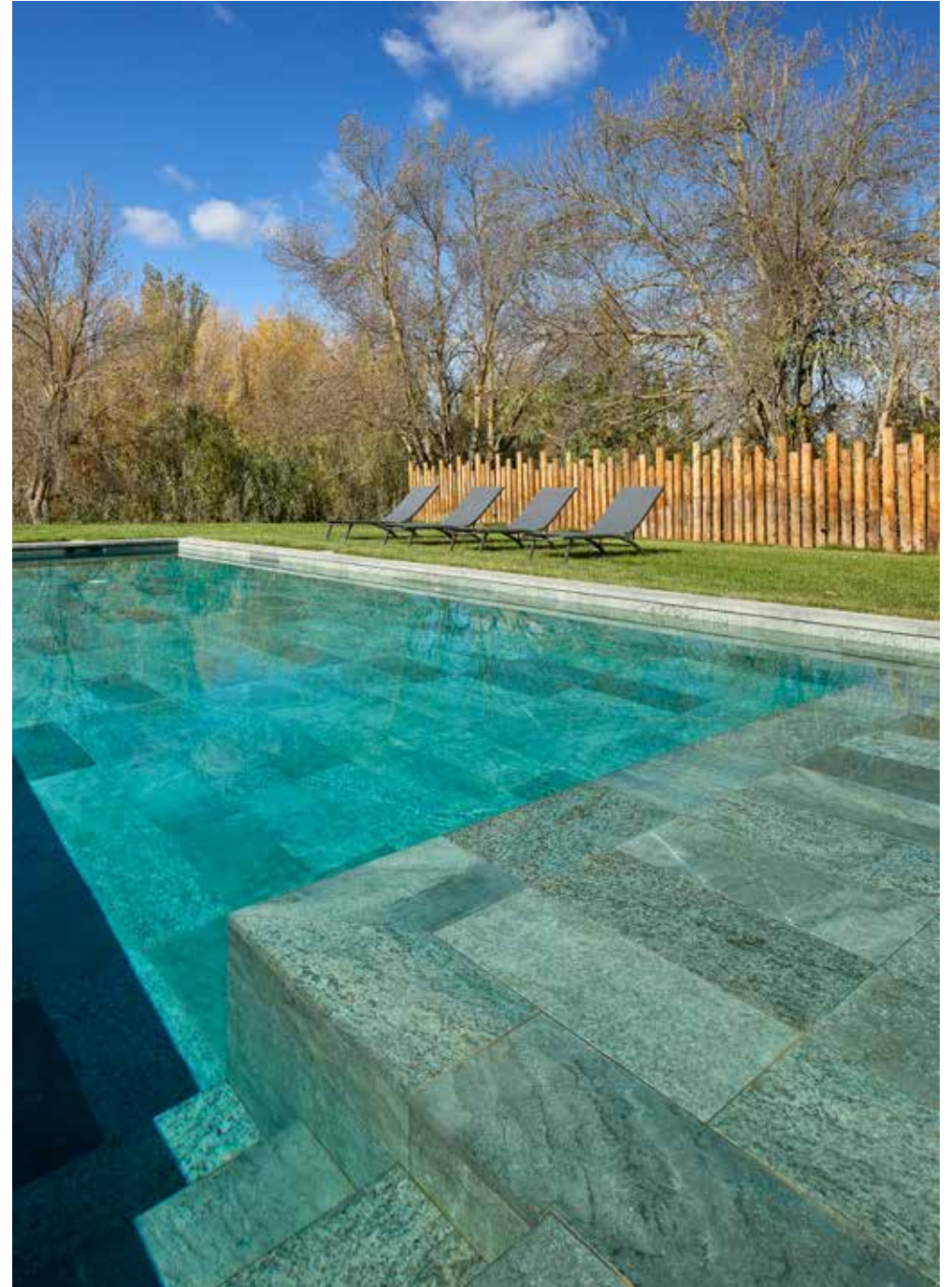





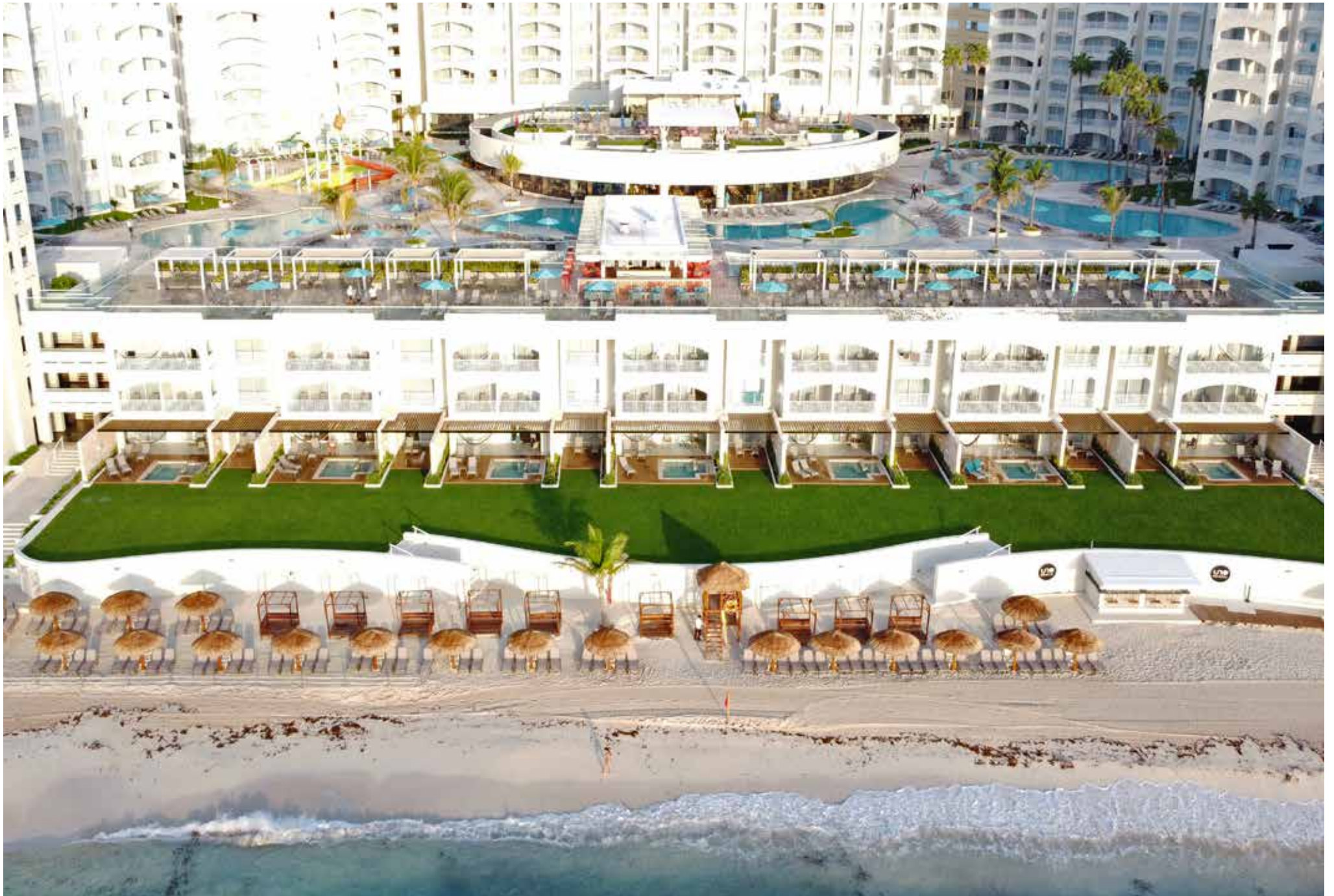

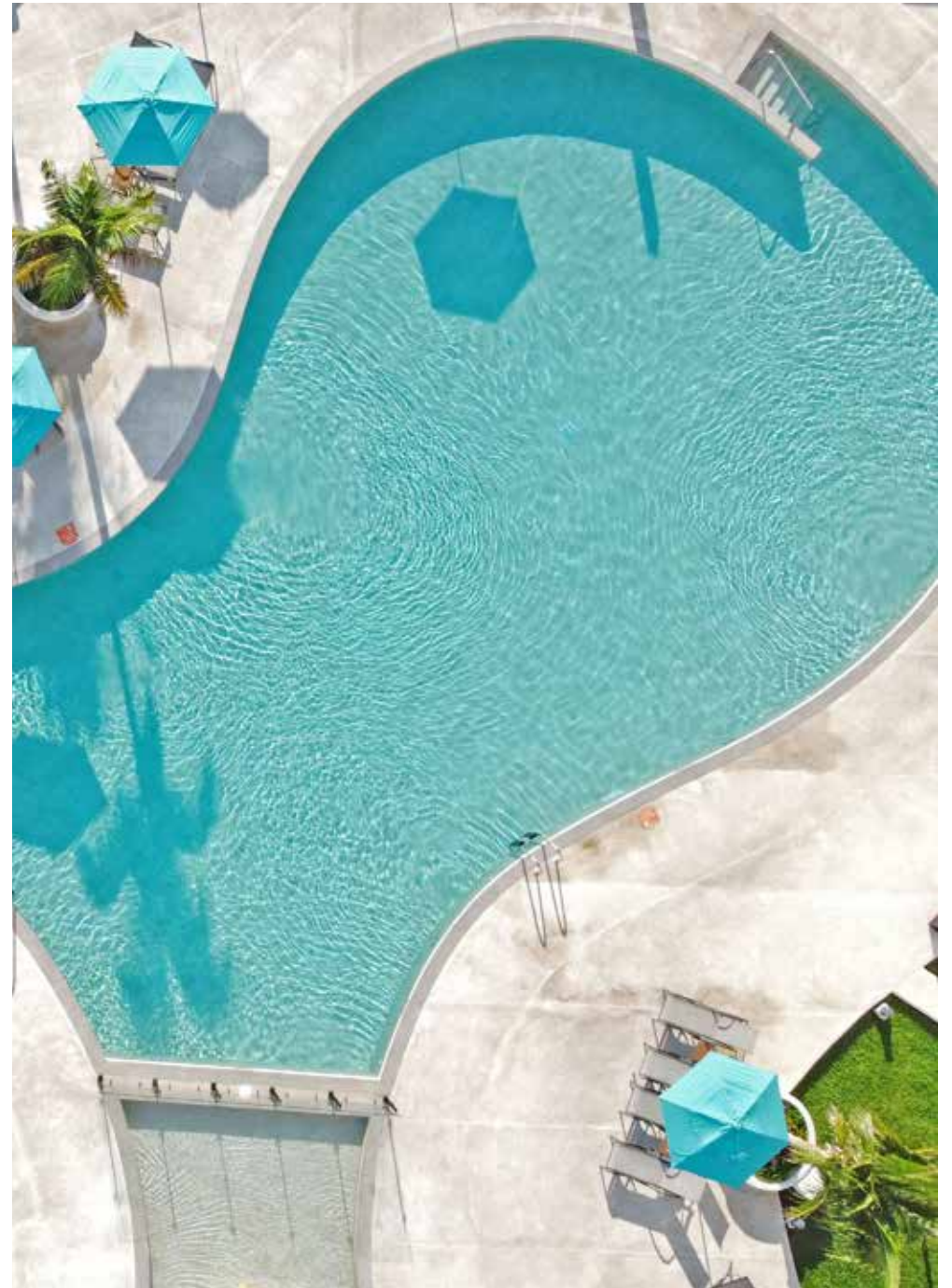







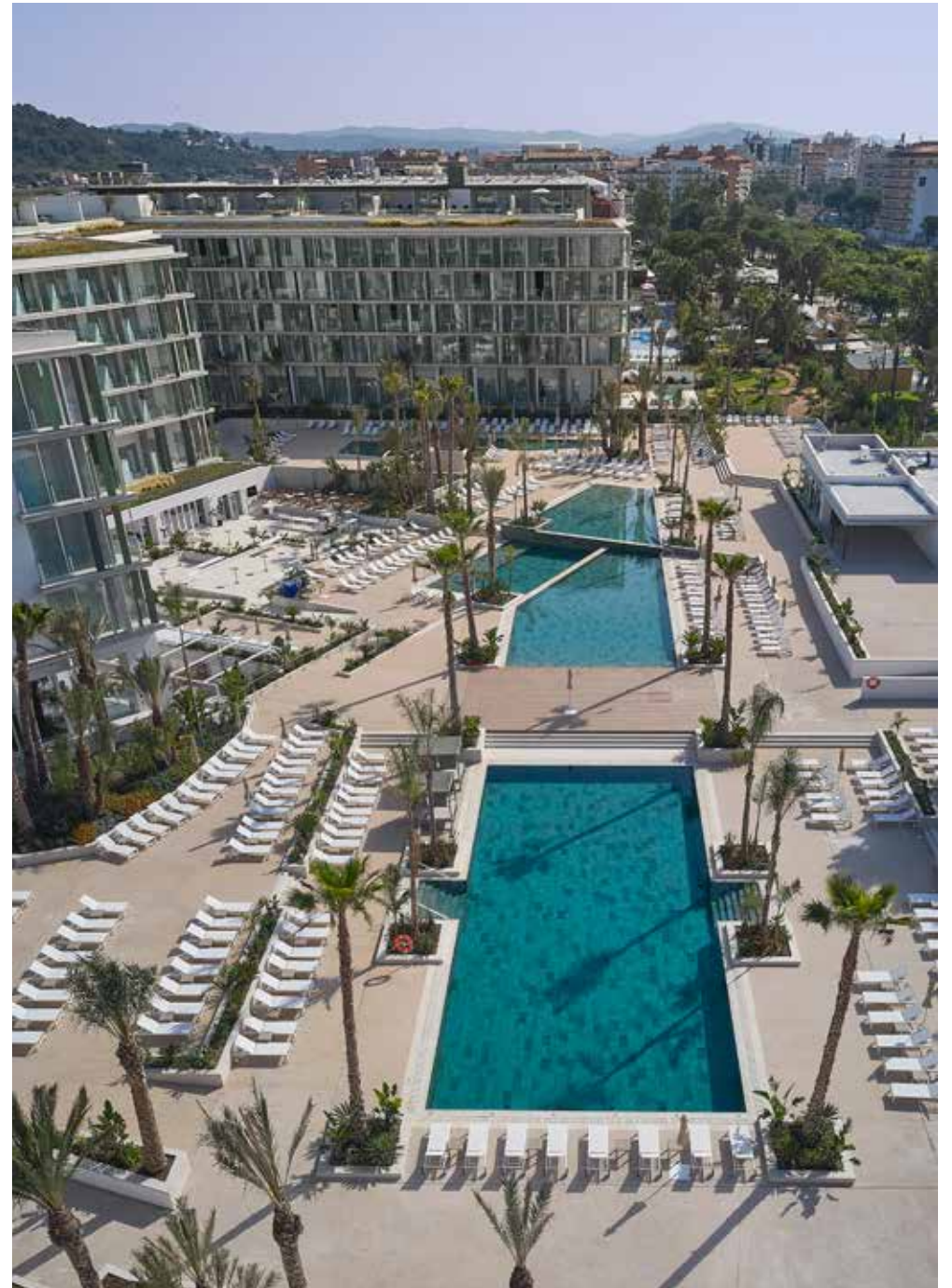



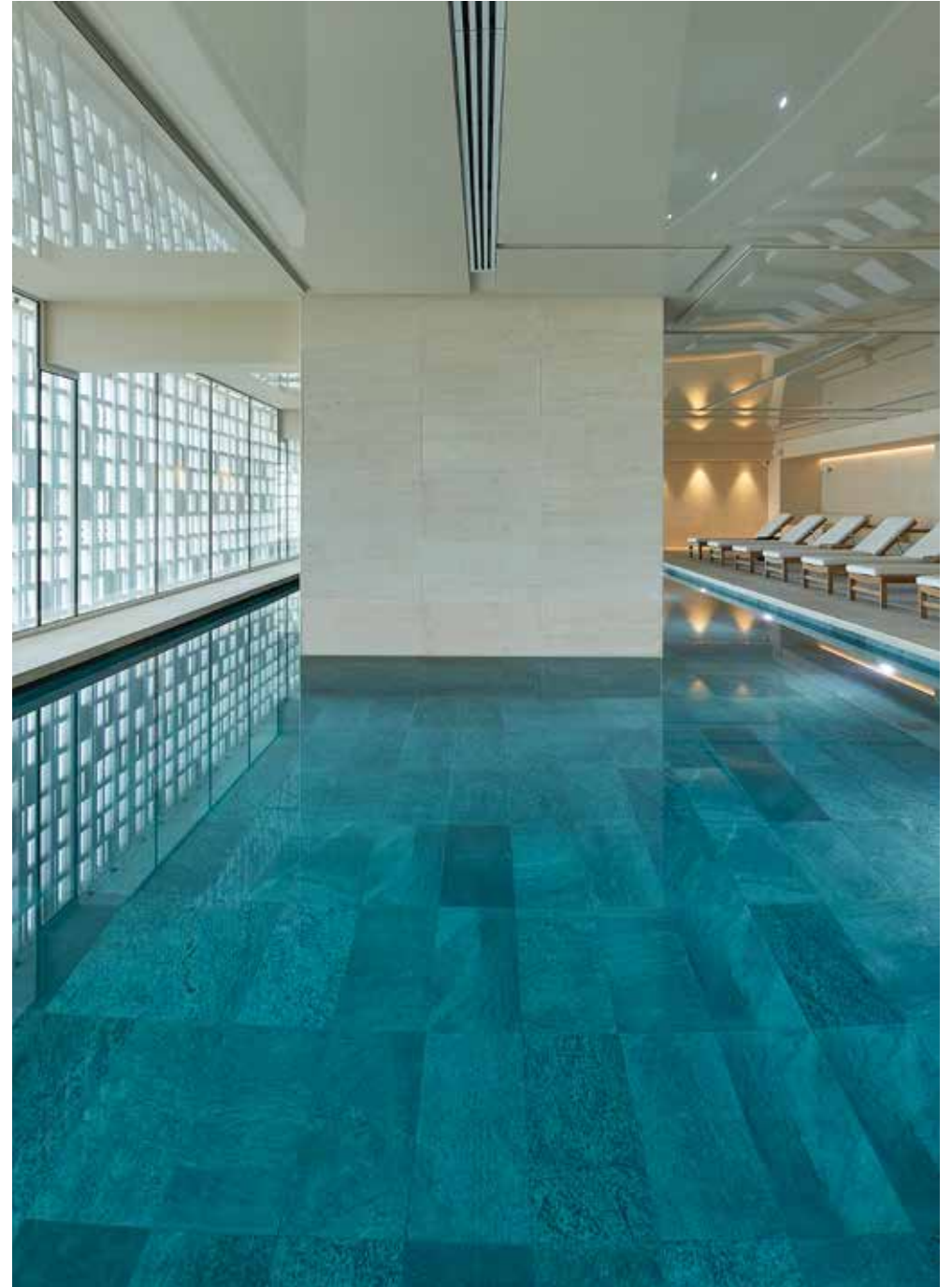



















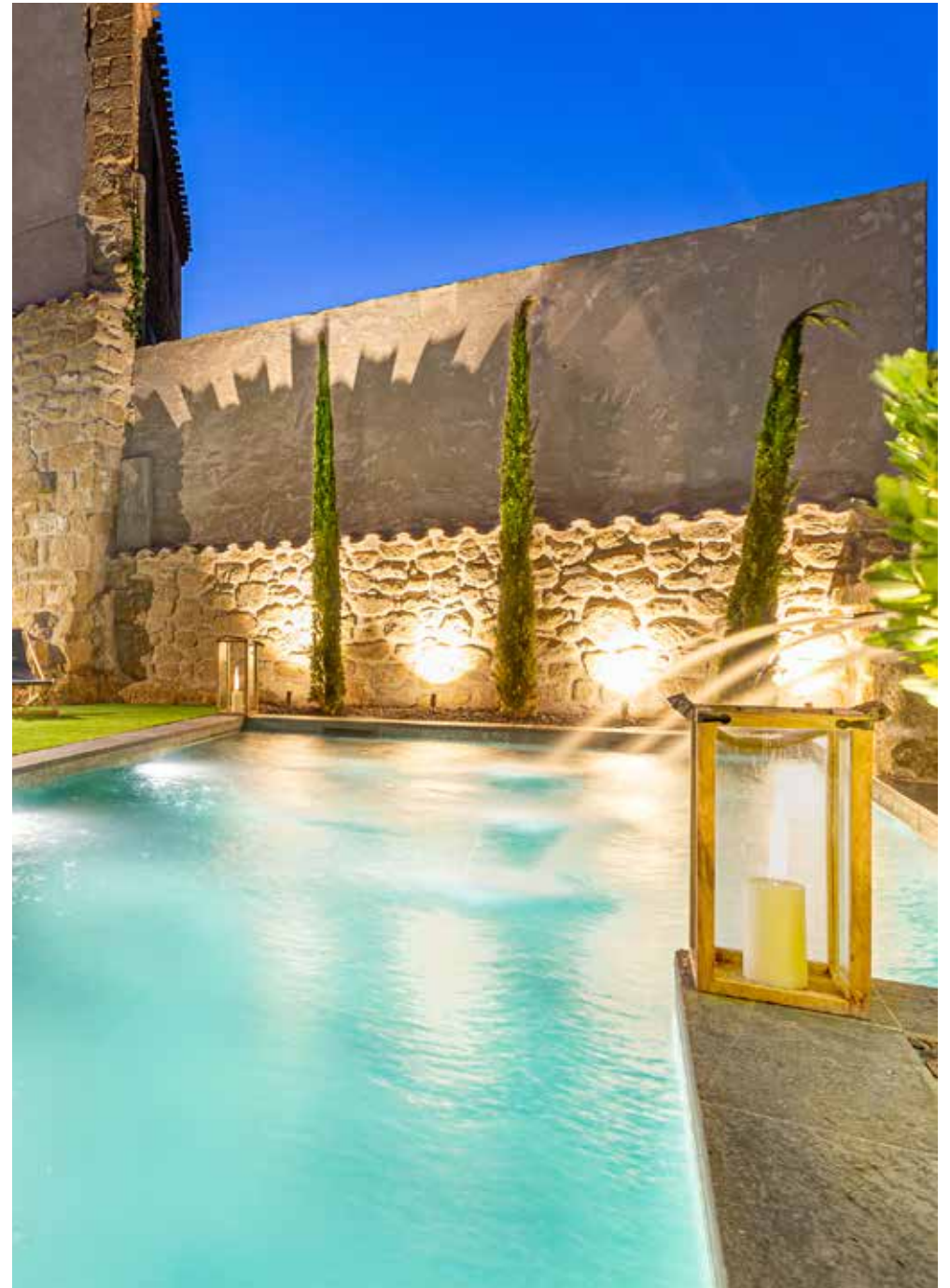













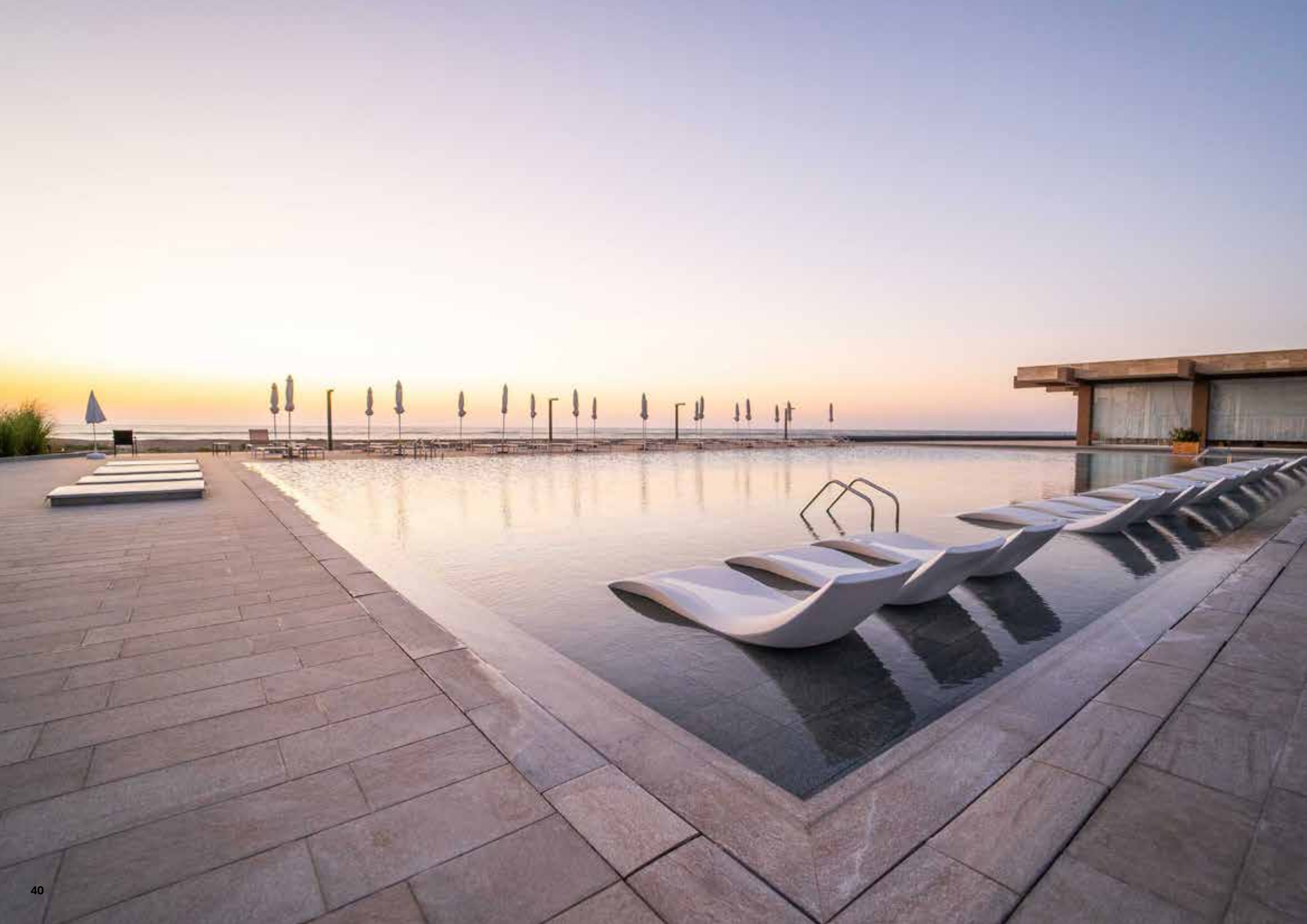









WALDDORF
WELLNESS

WALDDORF
WELLNESS

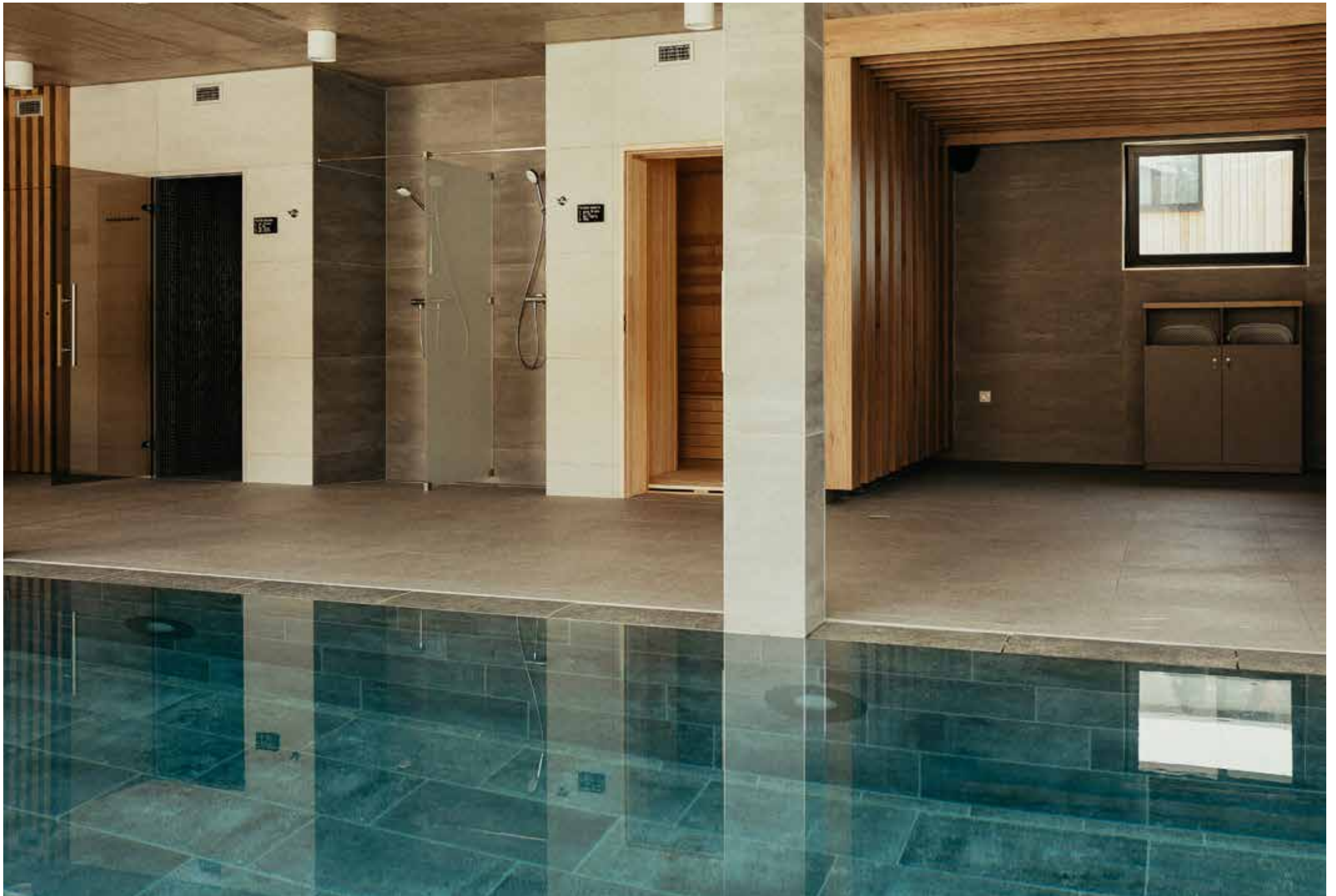







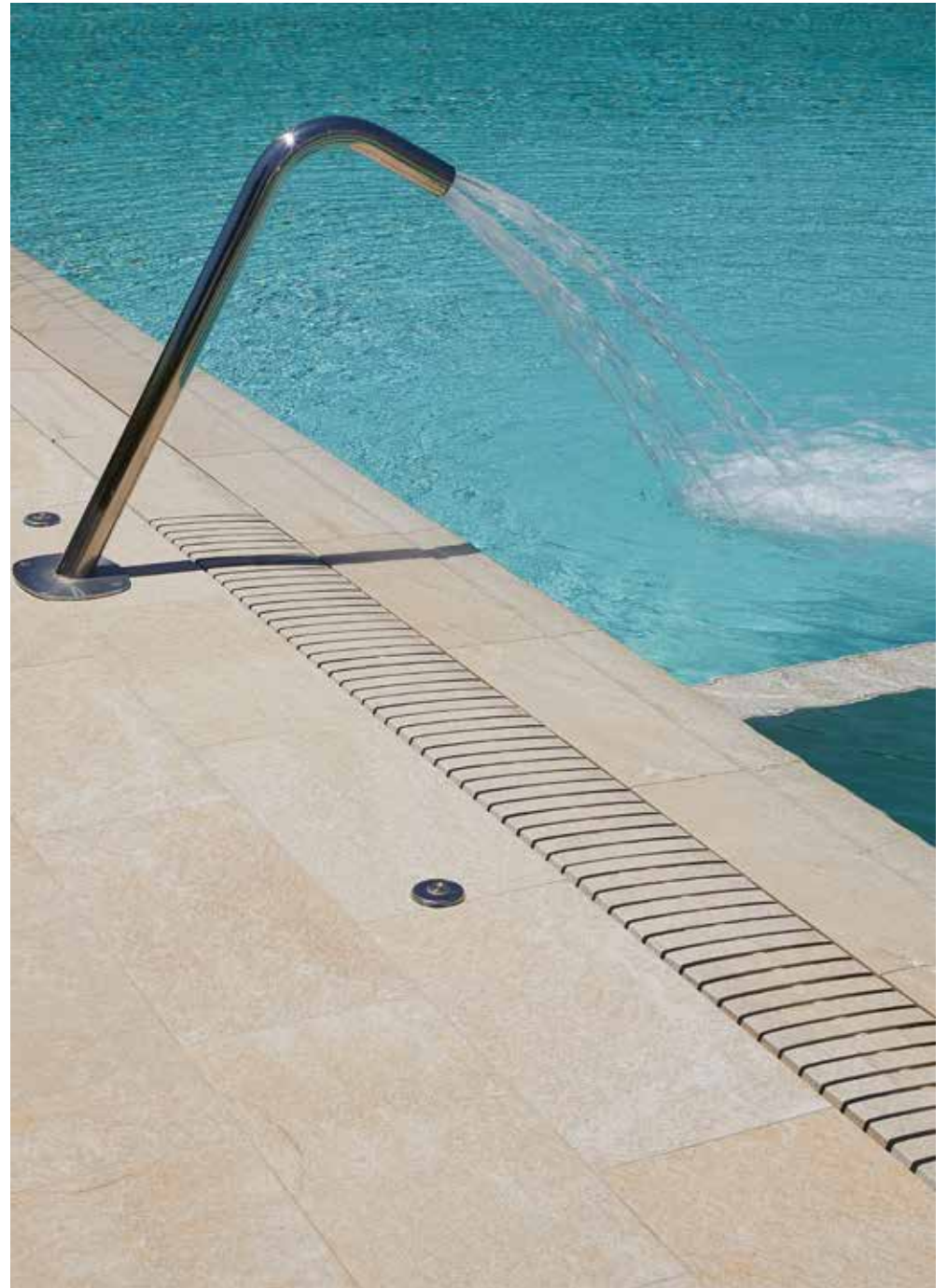



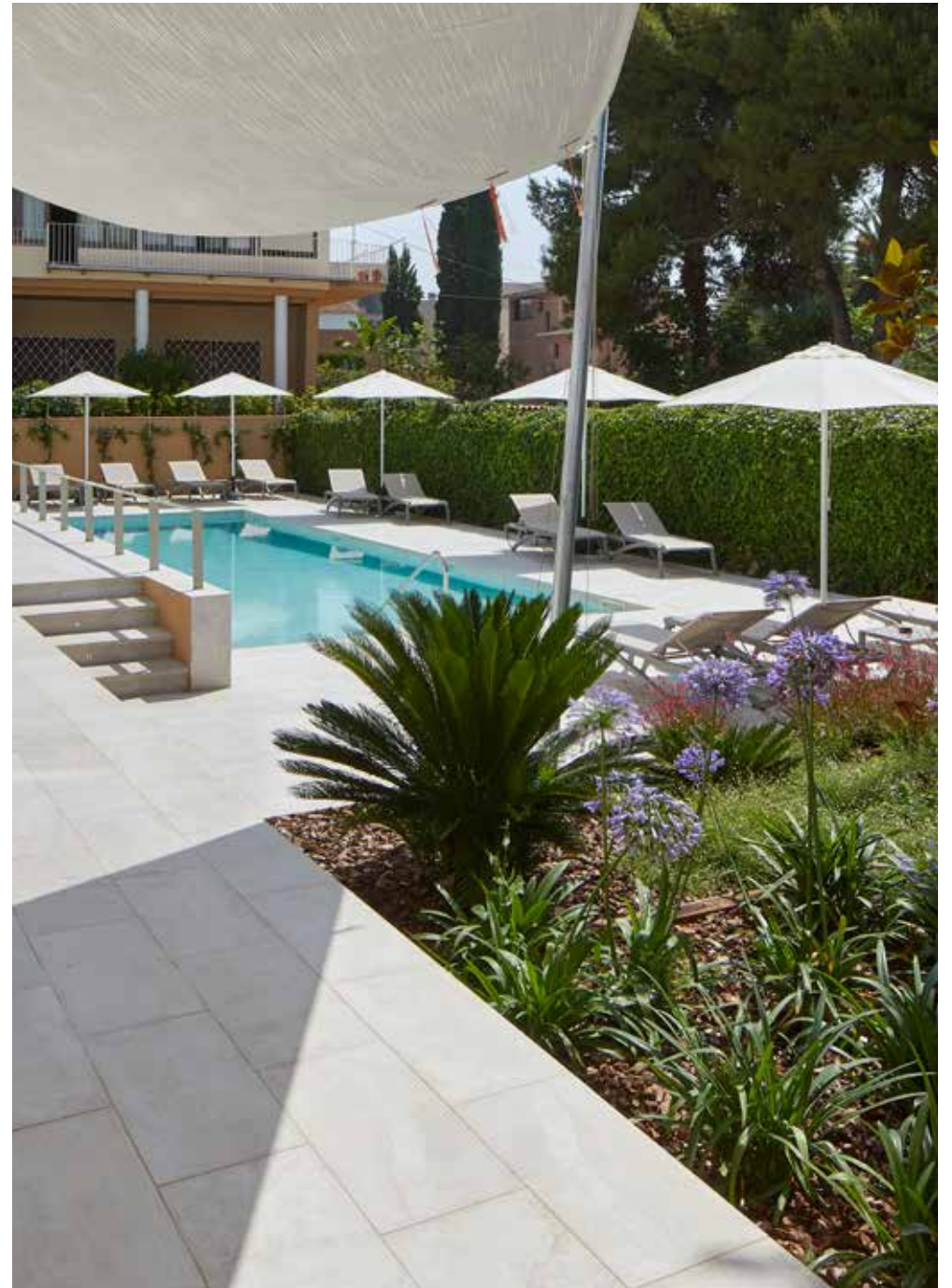



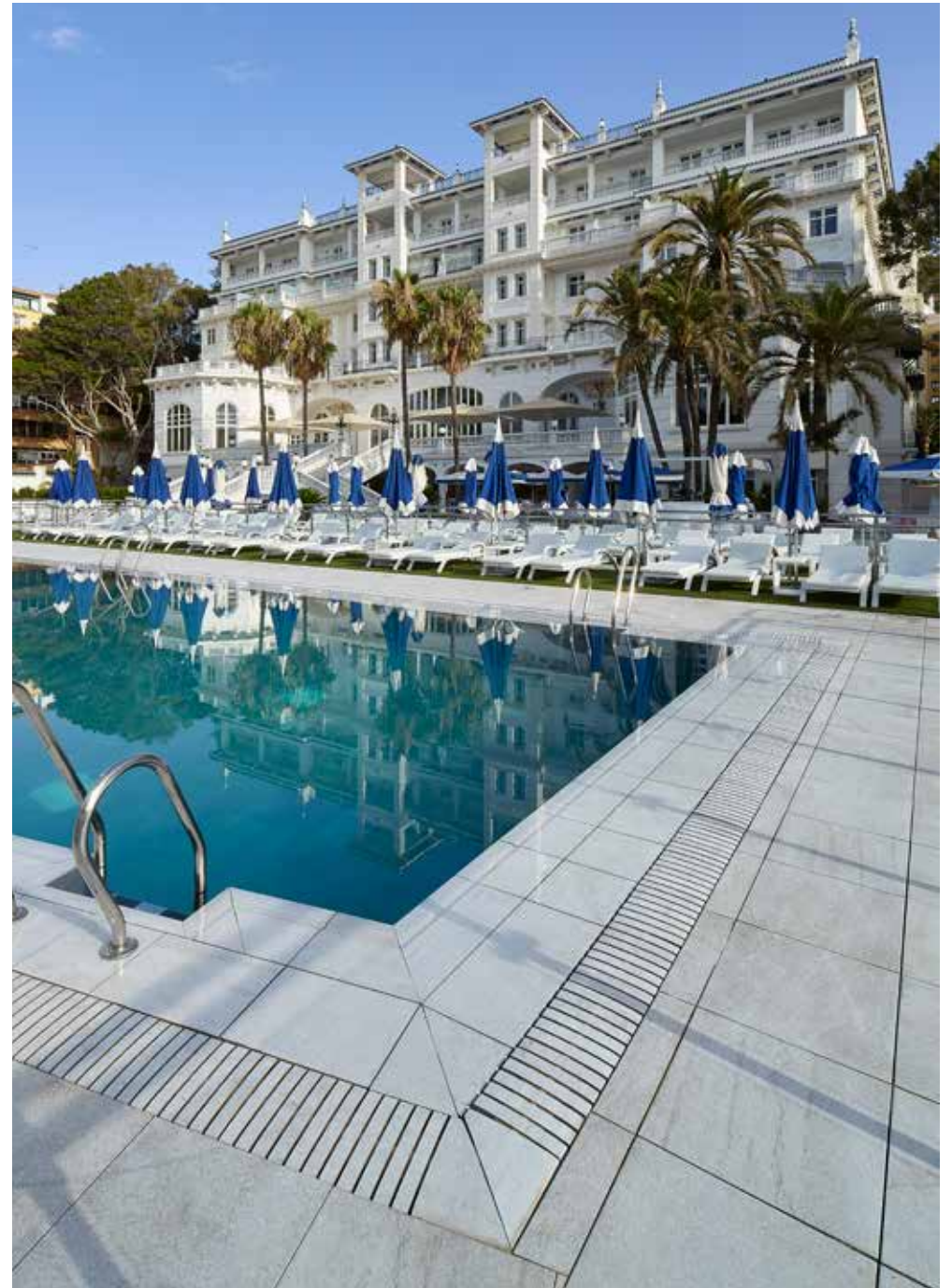



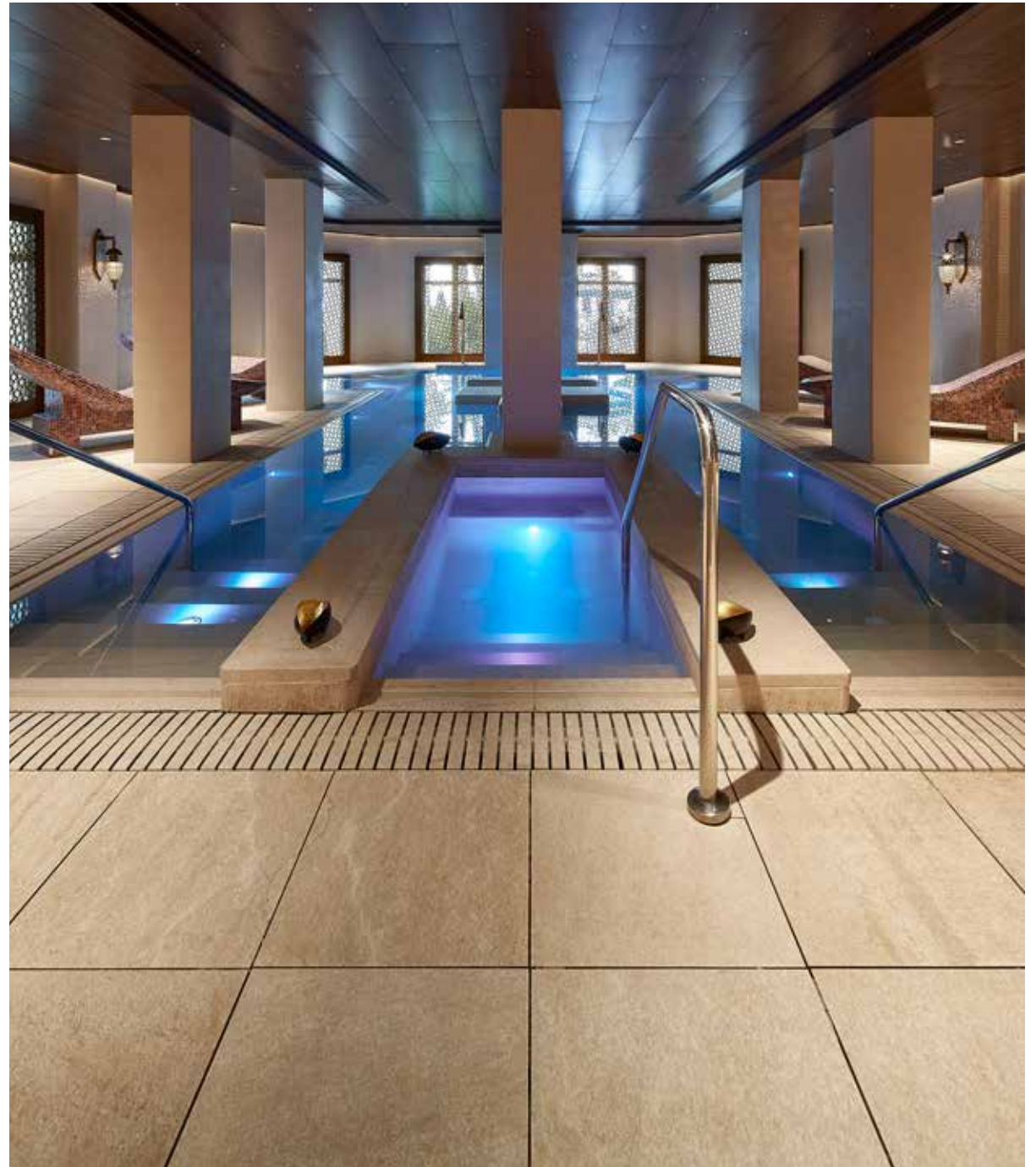
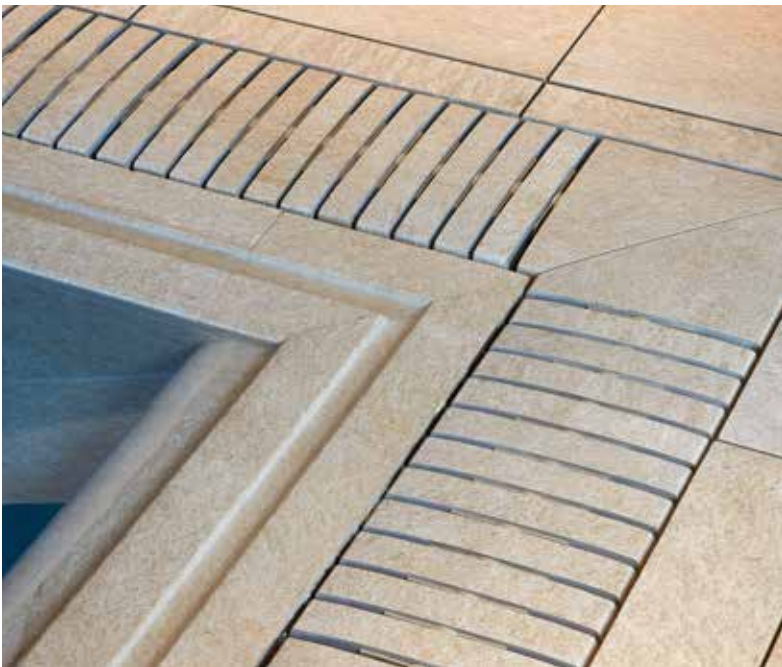



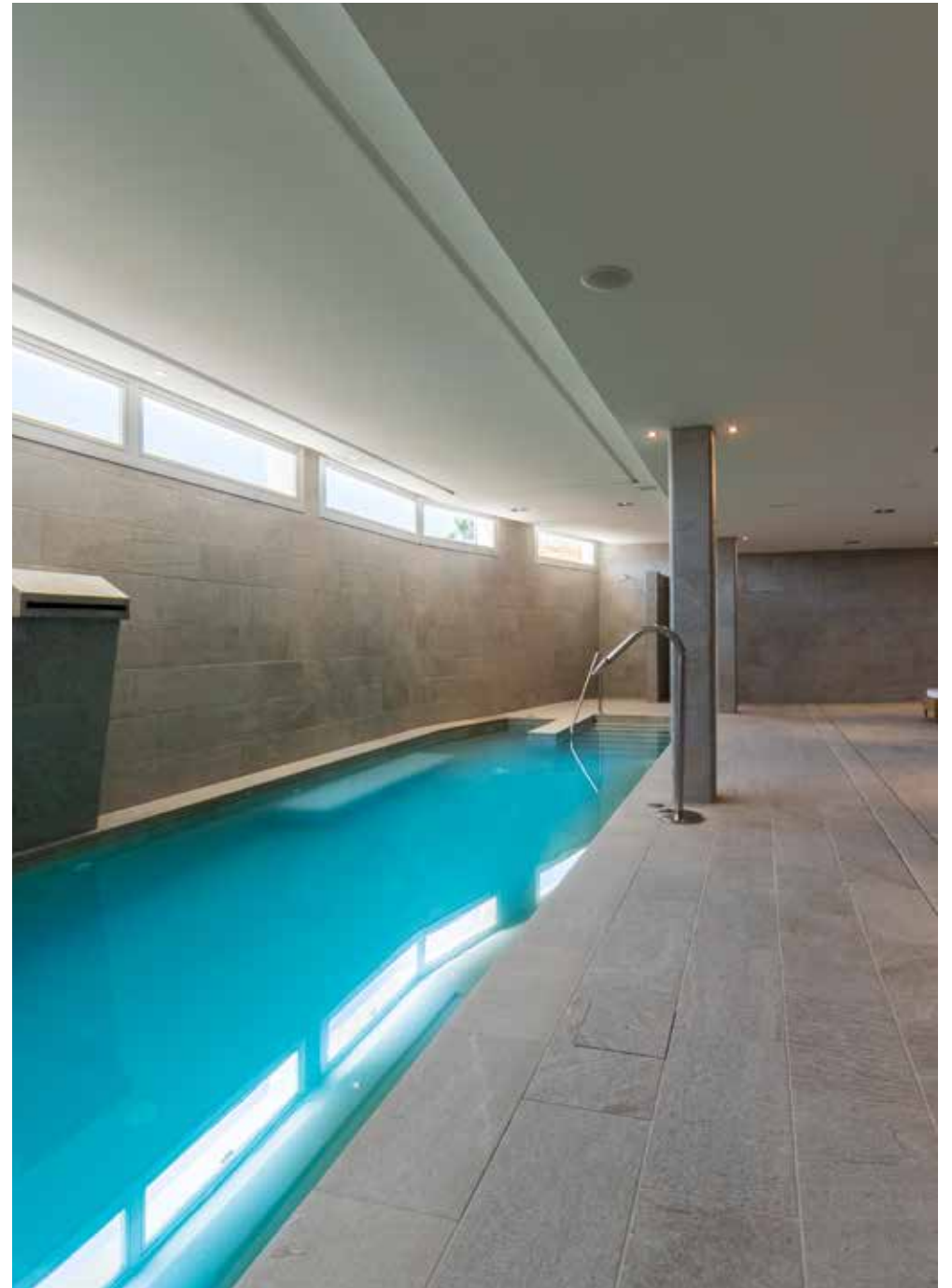

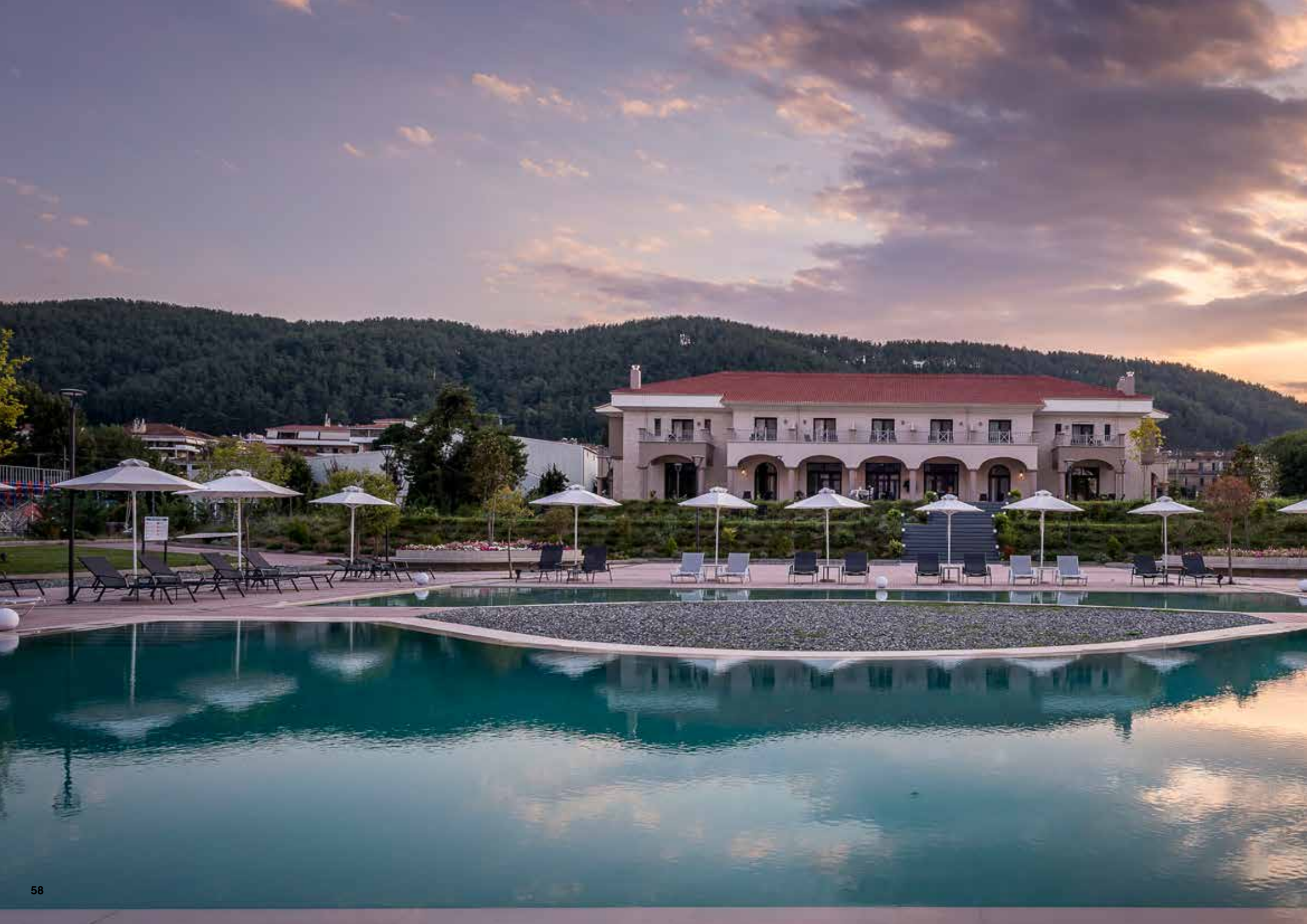

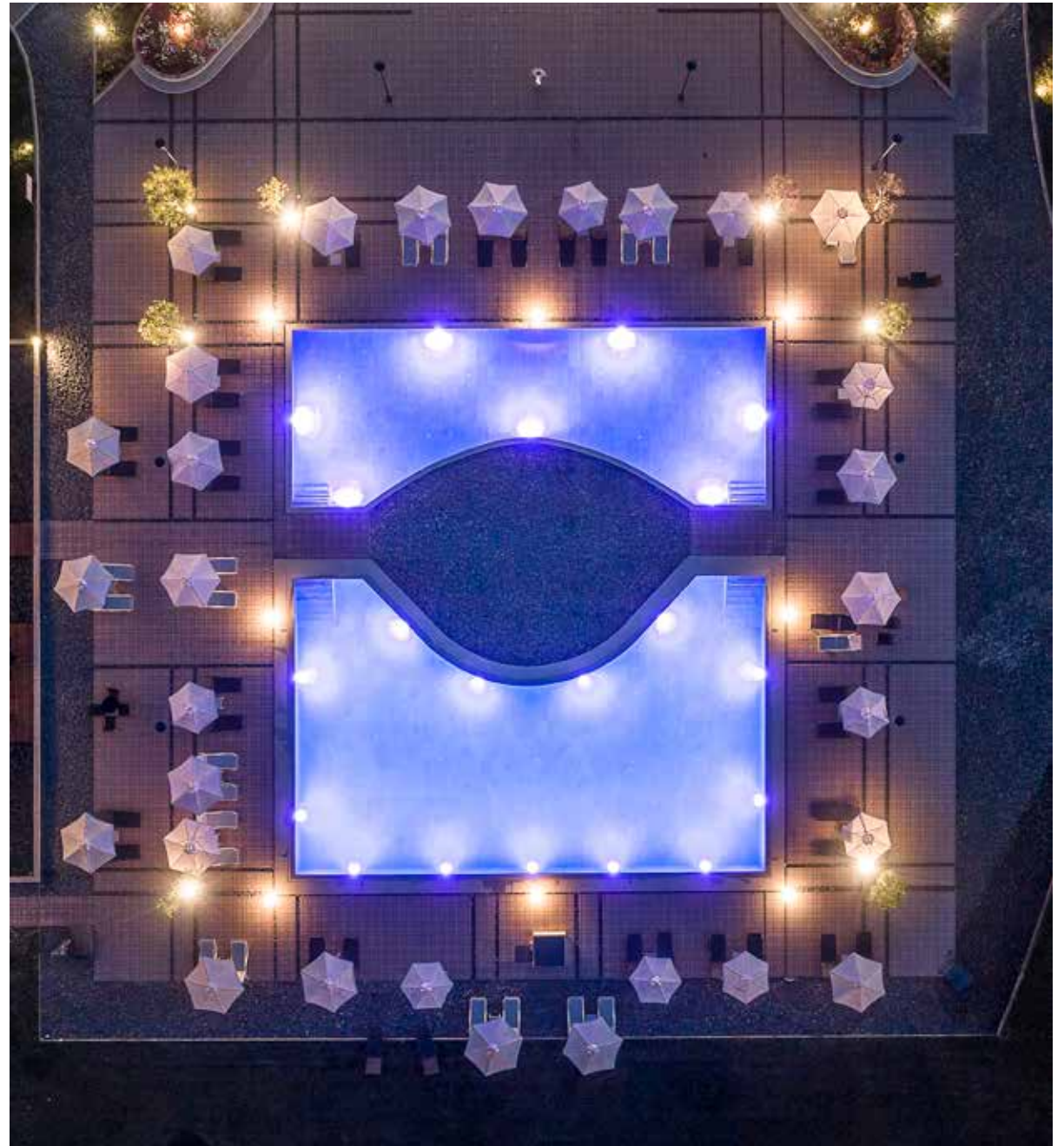















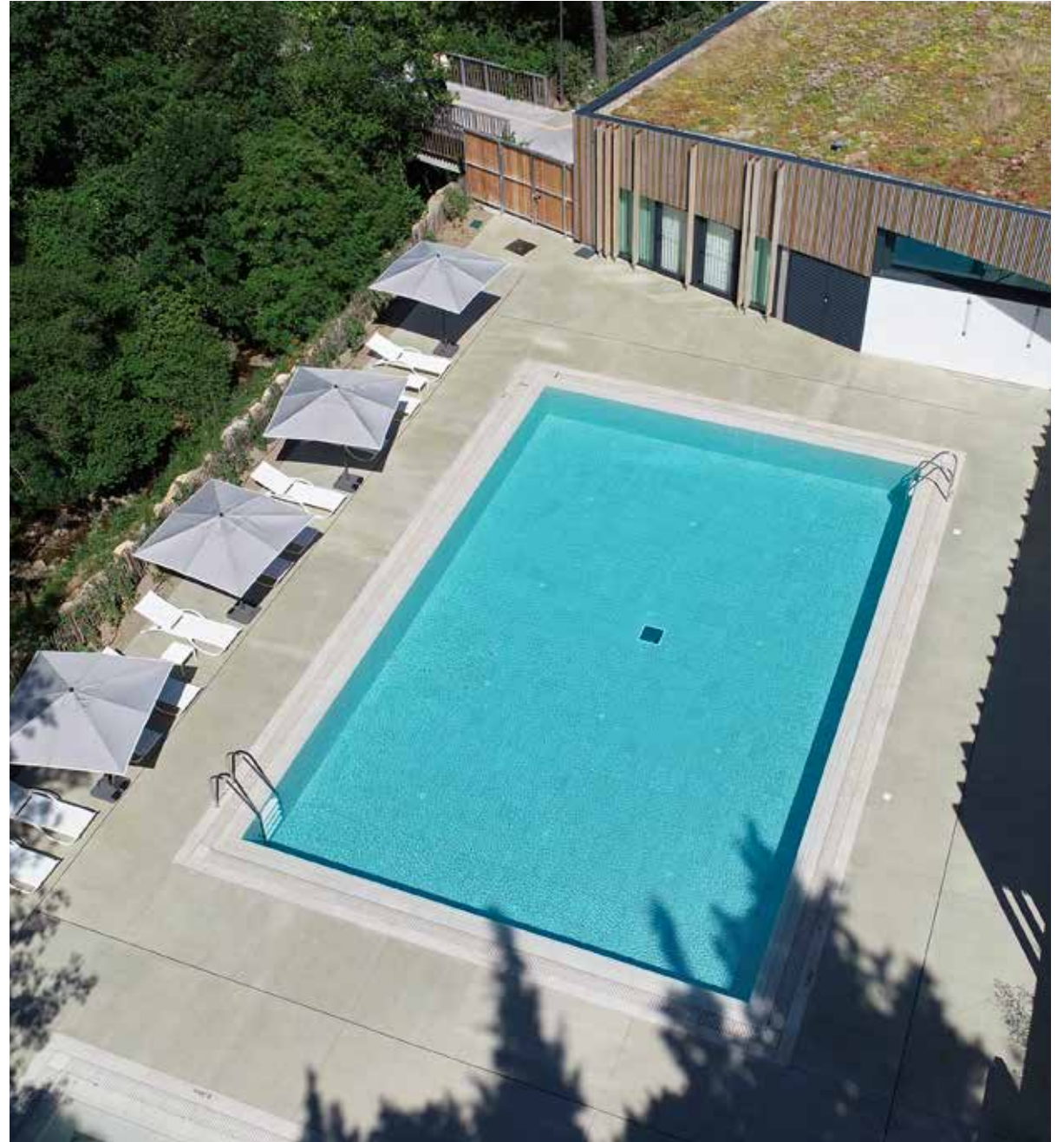







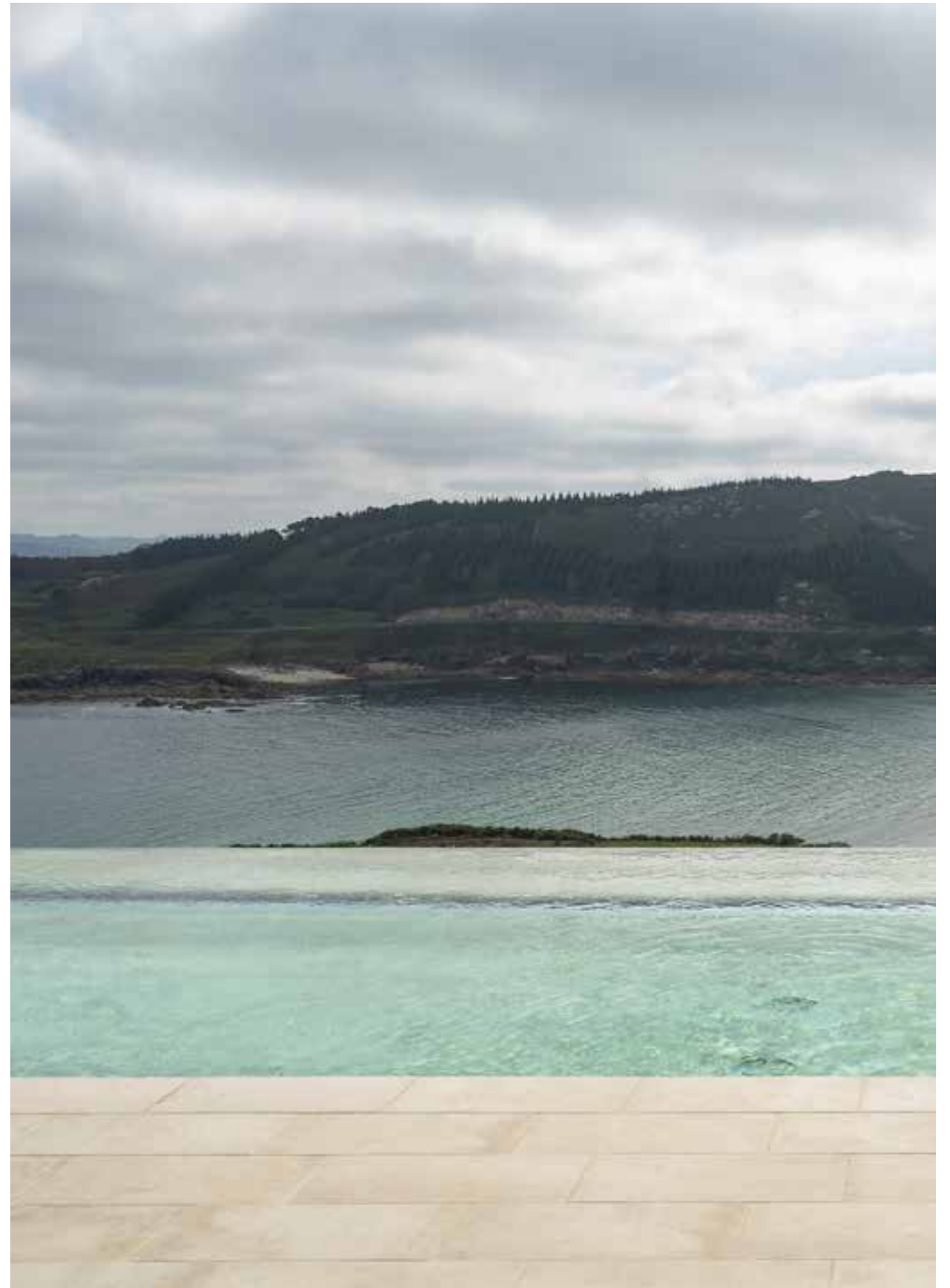



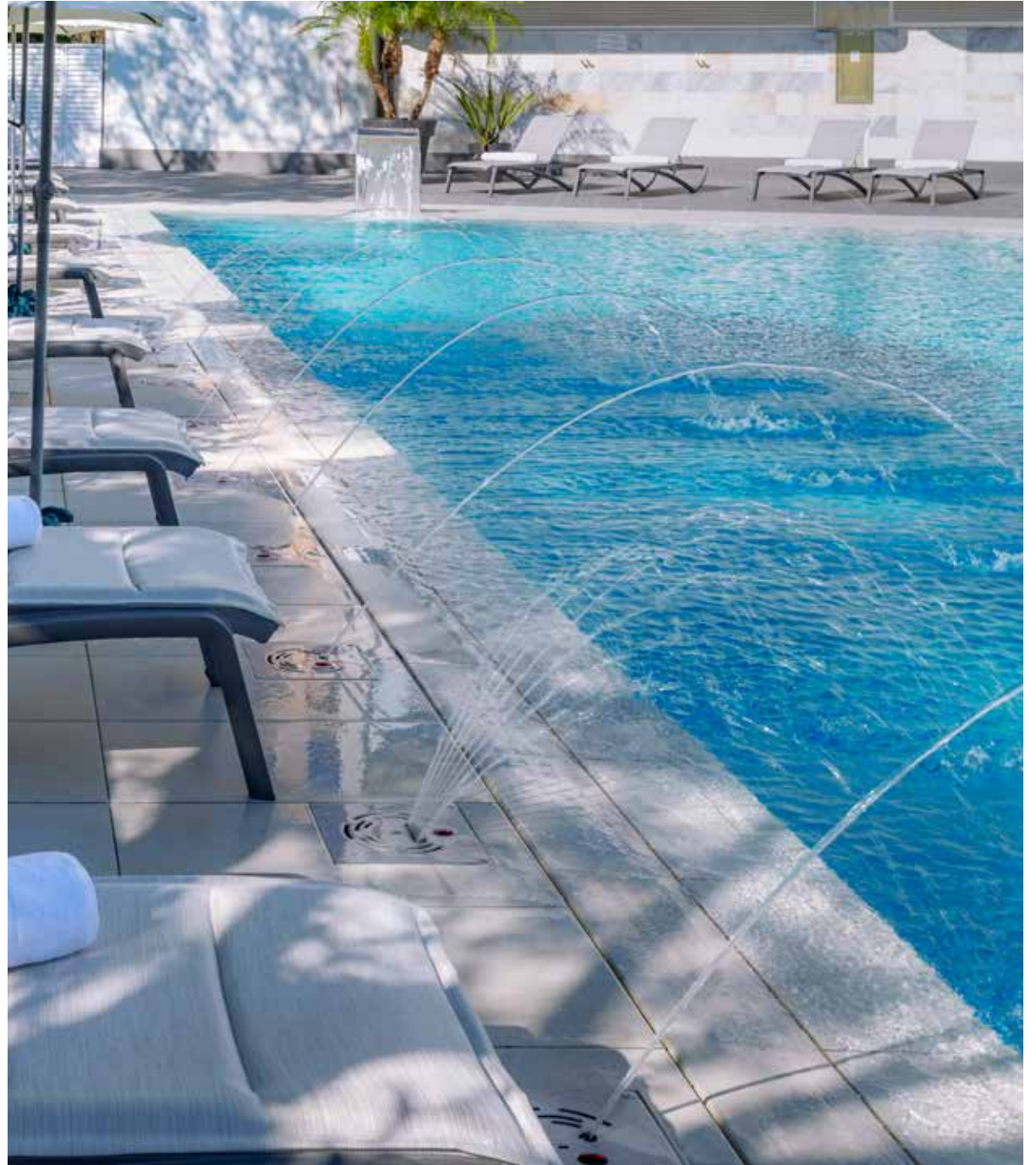







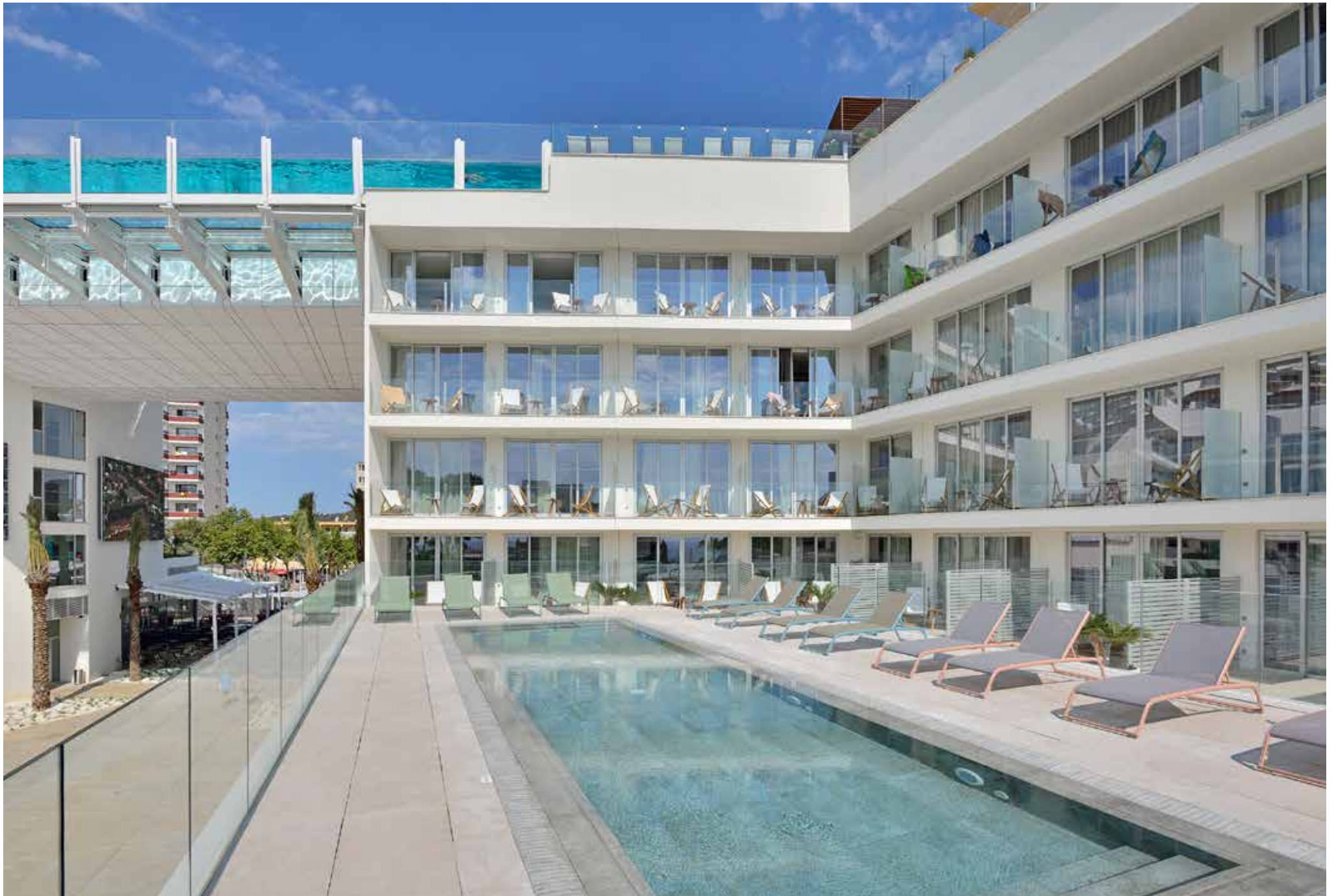

dream team



IMPLICADOS COMO UN VERDADERO PARTNER

Nuestro equipo técnico es experto en desarrollo y construcción de piscinas. Trabajamos con metodología BIM. Asesoramos a los profesionales y arquitectos durante todo el proceso constructivo.

FULLY INVOLVED LIKE A TRUE PARTNER

Our technical team are experts in the design and construction of swimming pools. We work with BIM methodology. We consult with contractors and architects throughout the construction process.

S'IMPLIQUER EN TANT QUE VERITABLE PARTENAIRE

Notre équipe technique est experte dans le développement et la construction de piscines. Nous travaillons avec la méthodologie BIM. Nous conseillons les professionnels et les architectes tout au long du processus de construction.

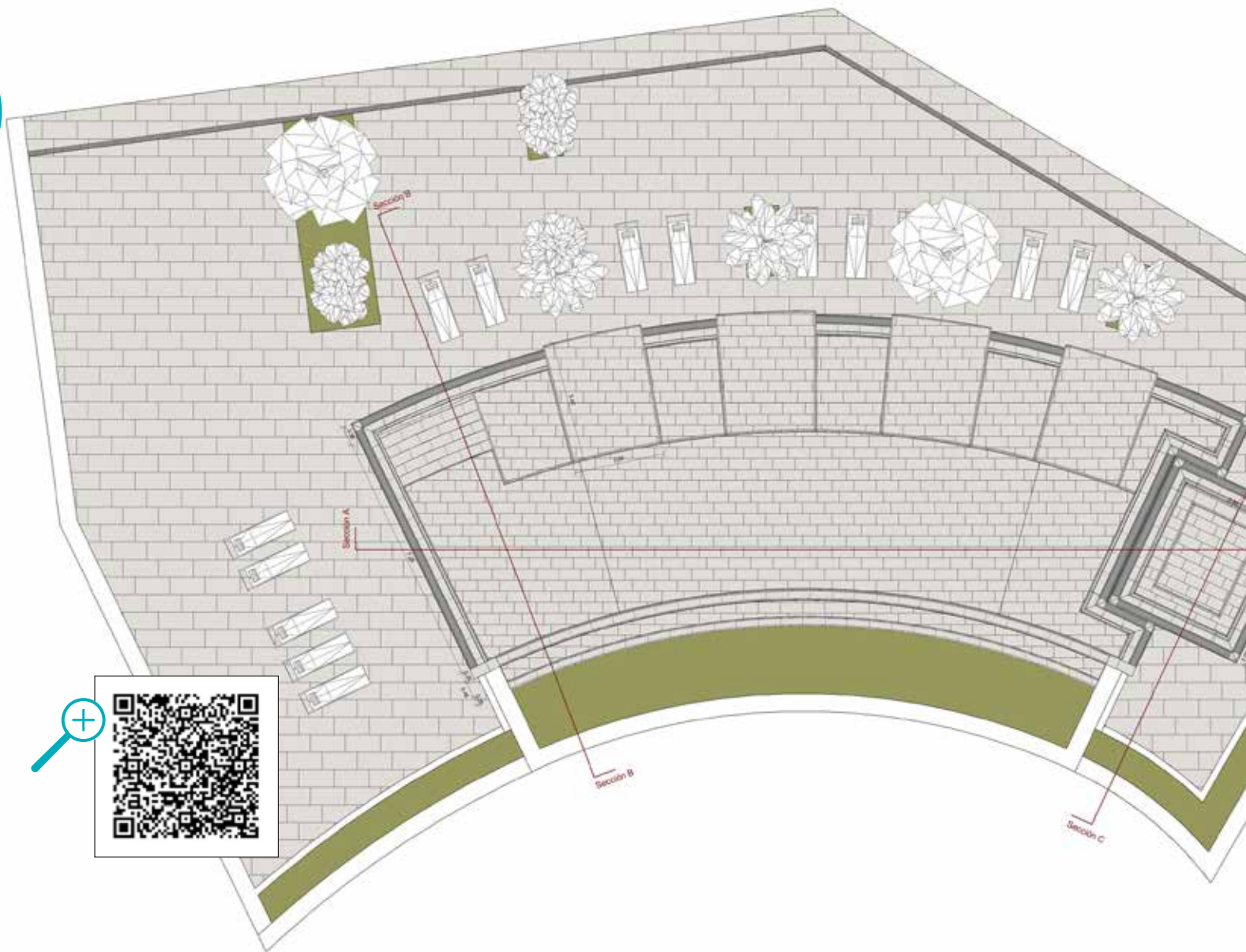
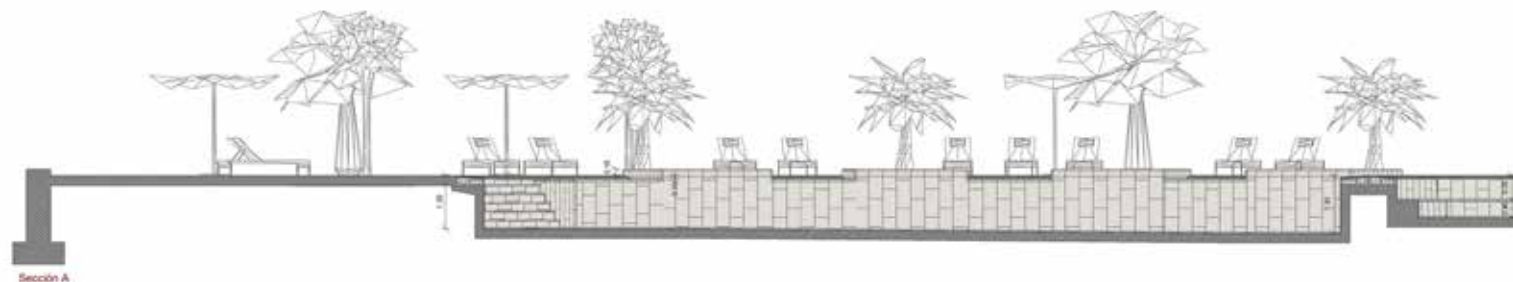



Royal Marina Suites Boutique Hotel | Puerto Calero, Lanzarote, Canary Islands, Spain



DESCUBRE NUESTRA ZONA PROFESIONALES

DISCOVER OUR PROFESSIONALS AREA

DÉCOUVREZ NOTRE ESPACE PROFESSIONNEL



RECURSOS BIM + CAD
BIM + CAD RESOURCES
RESSOURCES BIM + CAD



SISTEMAS CONSTRUCTIVOS PARA PISCINAS

CONSTRUCTION SYSTEMS FOR POOLS

SYSTÈMES DE CONSTRUCTION POUR PISCINES



COLORES Y TEXTURAS DESCARGABLES

COLORS AND TEXTURES AVAILABLE FOR DOWNLOAD

COULEURS ET TEXTURES TÉLÉCHARGEABLES



FICHAS TÉCNICAS Y MEMORIAS DESCRIPTIVAS

TECHNICAL DATA SHEETS AND SPECIFICATIONS

FICHES TECHNIQUES ET MÉMOIRES DESCRIPTIVES

dream team



DISEÑAR, PROYECTAR CONSTRUIR, DISFRUTAR

Para conseguir un acabado perfecto es imprescindible trabajar con las mejores soluciones constructivas. Sabemos que cada diseño es único. Contar con la experiencia de los productos **Fixcer** para la construcción nos garantiza el éxito final de todo el proyecto.

DESIGN, PLAN, BUILD, ENJOY

Achieving the perfect finish is only possible with the best construction solutions. We know that each design is unique. Trust in the expertise of **Fixcer** products for construction guarantees the success of the entire project.

CONCEVOIR, PLANIFIER CONSTRUIRE, APPRÉCIER

Pour obtenir une finition parfaite, il est essentiel de travailler avec les meilleures solutions de construction. Nous savons que chaque projet est unique. Faites confiance à l'expérience des produits **Fixcer** pour la construction garantit le succès final de l'ensemble du projet.

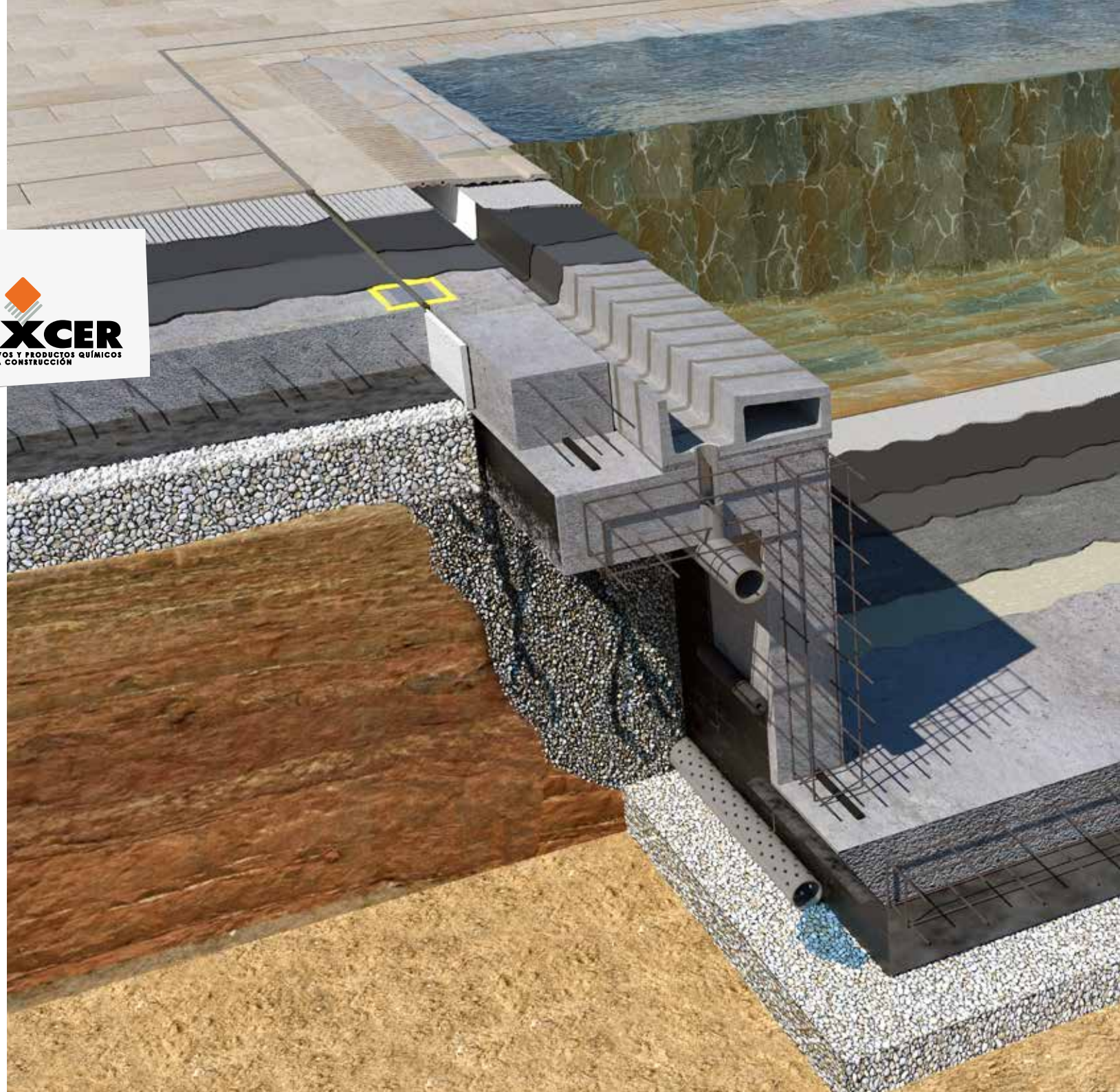



zero problems pools

- PEGAR
- REJUNTAR
- IMPERMEABILIZAR
- SELLAR
- FIXING
- GROUTING
- WATERPROOFING
- SEALING
- COLLER
- JOINTOYER
- IMPERMÉABILISER
- SCELLER

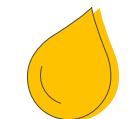

ZERO FUGAS
PISCINA 100% ESTANCA
ZERO LEAKS
100% WATERTIGHT POOLS
ZÉRO FUITE
PISCINE 100% ÉTANCHE

MÁS DE 1.000.000 de m²
DE PISCINAS REALIZADOS
OVER 1,000,000 m²
OF POOL INSTALLATIONS
PLUS DE 1.000.000 m²
DE PISCINES RÉALISÉES

CONSUMO DEL AGUA
MÁS SOSTENIBLE
MORE SUSTAINABLE
USE OF WATER
UTILISATION PLUS
RESPONSABLE DE L'EAU

LA SOLIDEZ CONSTRUCTIVA
ALARGA LA VIDA DE LA PISCINA
SOLID CONSTRUCTION FOR GREATER
DURABILITY
LA SOLIDITÉ DE LA CONSTRUCTION
PROLONGE LA DURÉE DE VIE DE LA PISCINE

REDUCCIÓN DE LOS COSTES
DE MANTENIMIENTO
REDUCED
MAINTENANCE COSTS
RÉDUCTION DES
COÛTS D'ENTRETIEN

FABRICACIÓN SOSTENIBLE
NORMA EN14.001
SUSTAINABLE MANUFACTURING
STANDARD EN14.001
FABRICATION DURABLE
NORME EN14.001

MAXIMUM SAFETY

Rosa Gres fabrica uno de los acabados antideslizantes de gres porcelánico más seguros del mercado. Es agradable al tacto y fácil de limpiar. **¿Cómo funciona?** Al pisar el pavimento húmedo se produce un efecto ventosa y de agarre al suelo que evita el deslizamiento

Rosa Gres produces one of the safest non-slip porcelain stoneware surfaces on the market. It is pleasant to the touch and easy to clean. **How does it work?** When stepping on the wet tile, it produces a suction and grip effect that prevents slipping.

Rosa Gres fabrique l'un des revêtements de sol antidérapants en grès cérame les plus sûrs du marché. C'est un matériau agréable au toucher et facile à nettoyer. **Comment fonctionne-t-il ?** Le fait de marcher sur le sol mouillé produit un effet d'aspiration et d'adhérence qui empêche de glisser.





SOLAR REFLEC TANCE IRS

El gres porcelánico Rosa Gres expuesto a la luz del sol presenta un excelente comportamiento atérmico. En todos los casos, los colores claros se calientan menos que los colores oscuros.

Rosa Gres porcelain stoneware has excellent Solar Reflectance Index. Lighter colors always heat up less than darker colors.

Le grès cérame Rosa Gres exposé à la lumière du soleil a un excellent comportement thermique. Dans tous les cas, les couleurs claires se réchauffent moins que les couleurs foncées.

MAXIMUM SECURITY

NEW

NUEVO ACABADO ANTIDESLIZANTE PASTILLA

Nuevos colores con el acabado pastilla. Es ideal para zonas con tránsito descalzo y presencia de agua. Con los nuevos colores, el acabado pastilla se viste de diseño.

NEW NON-SLIP "PASTILLA" FINISH

New colors available with the diamond finish. Ideal for areas with barefoot traffic and the presence of water. These new colors add a designer touch to the Pastilla finish.

NOUVELLE FINITION ANTIDÉRAPANTE "PASTILLA"

Nouvelles couleurs avec la finition structurée. Elle est idéale pour les zones où l'on circule pieds nus et où il y a de l'eau. Avec les nouvelles couleurs, la finition tablette s'habille de design.

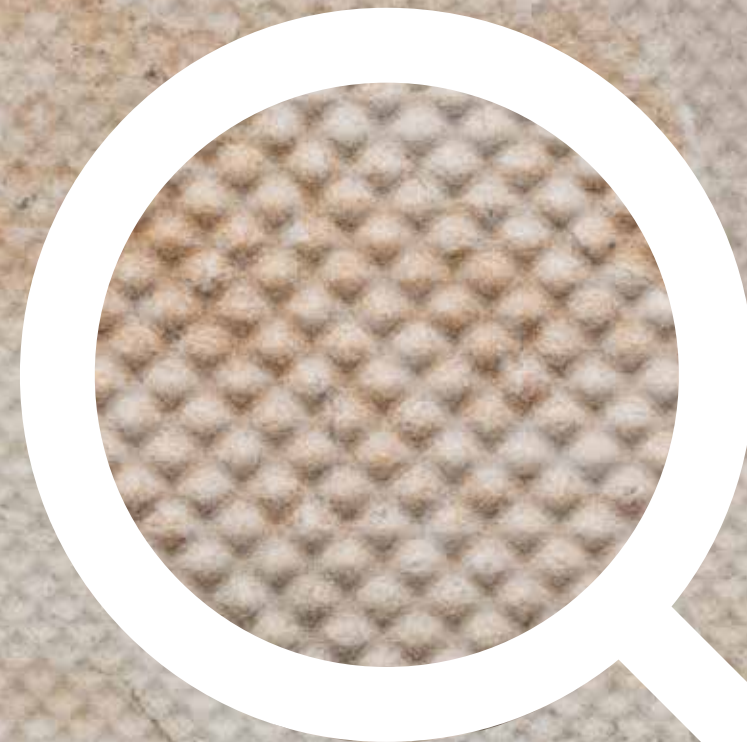



Pietro White Pastilla 31 x 62,6



Pietro Golden Pastilla 31 x 62,6



Pietro Grey Pastilla 31 x 62,6



Pietro Dark Pastilla 31 x 62,6



Iconic White Pastilla 31 x 62,6



Iconic Grey Pastilla 31 x 62,6



Iconic Dark Pastilla 31 x 62,6

EN 16165
(DIN 51097)
Anexo A

CLASE C
≥ 24°

EN 16165
(DIN51130)

R11
> 19° - 27°

DIN51130

V4

EN 16165
(UNE 41901)

CLASE 3
RD > 45

EVITA
EL EFECTO
"AQUAPLANING"
CON PIE
DESNUDO

ELIMINATE THE
AQUAPLANING
EFFECT WITH
BARE FEET

CELA PERMET
D'ÉVITER
"L'AQUAPLANING"
PIEDS NUS

ECO design

Draining pavement



NUEVO PAVIMENTO DRENANTE DE DISEÑO

- No rompe el ciclo del agua
- No necesita pendientes ni canalizaciones
- Alta capacidad drenante
- Juntas resistentes, sin mantenimiento
- Acabado porcelánico de diseño Rosa Gres

NEW DESIGNER FLOORING WITH DRAINAGE

- Does not disrupt the water cycle
- No need for slopes or channels
- High drainage capacity
- Durable joints, no maintenance
- Rosa Gres designer porcelain stoneware finish

SOL PER CHAUSSÉE DRAINANTE NOUVELLE CONCEPTION

- Ne rompt pas le cycle de l'eau
- Pas besoin de pentes ou de canalisations
- Grande capacité de drainage
- Joints résistants sans entretien
- Finition en grès cérame design Rosa Gres

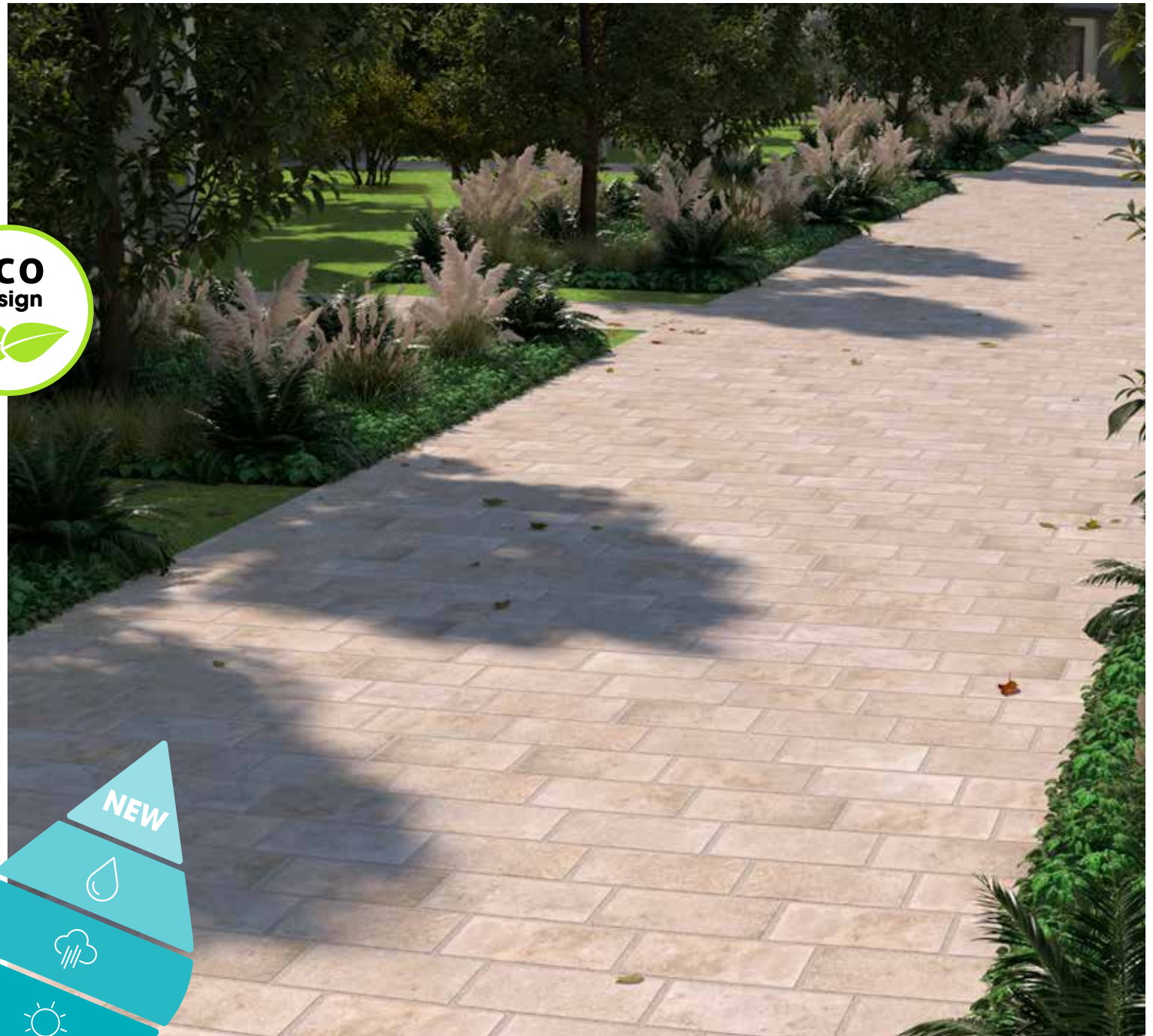

1

Sanear y nivelar el terreno.
Colocar la capa de grava.

Prepare and level the site.
Lay the gravel.

Nettoyer et niveler le sol.
Poser la couche de gravier.



2

Aplicar MORTER DRAIN regleado encima de la grava.

Apply MORTER DRAIN over the gravel.

Appliquer MORTER DRAIN sur le gravier.



3

Una vez aplicado dejar fraguar el mortero, cubriéndolo con un plástico durante 48 horas.

Once applied, leave the mortar to set and cover with plastic for 48 hours.

Une fois le mortier appliqué, il faut le laisser durcir en le recouvrant d'un film plastique pendant 48 heures.



4

Pegar las piezas de Gres porcelánico con cemento cola FIXAFLEX GEL manteniendo el ancho de la junta necesario según los requisitos de drenaje previstos.

Fix the porcelain stoneware pieces with FIXAFLEX GEL tile adhesive, maintaining the required joint width according to the drainage requirements.

Coller les pièces en grès cérame avec le ciment-colle FIXAFLEX GEL en respectant la largeur de joint nécessaire en fonction des exigences de drainage.



5

Pasadas 24 horas rejuntar con JUNTA DRAIN.

After 24 hours, grout with JUNTA DRAIN.

Après 24 heures, jointoyer avec JUNTA DRAIN



6

Al cabo de 24 horas el suelo ya es totalmente utilizable.

Flooring is fully usable after 24 hours.

Après 24 heures, le sol est entièrement utilisable.



¿Cómo funciona?
VER VIDEO

How does it work?
WATCH VIDEO

Comment cela
fonctionne-t-il ?
VOIR LA VIDEO

CONSTRUCCIÓN INDUSTRIALIZADA DE PISCINAS
 INDUSTRIALIZED POOL CONSTRUCTION
 CONSTRUCTION INDUSTRIALISÉE DE PISCINES



SISTEMA 9

Coronamiento prefabricado formado por bloques de hormigón hidrófugo. Cada pieza funciona como canal y soporte de la cerámica. Se integra perfectamente con todos nuestros Sistemas Desbordantes.

THE 9 SYSTEM

Prefabricated overflow channel of water resistant concrete blocks. Each piece acts as a channel and support for the ceramic tile. Integrates perfectly with all our overflow systems.

SYSTÈME 9

Canal fabricado en bloques de béton hydrofuges. Chaque pièce sert de canal et de support pour les céramiques. Elle s'intègre parfaitement à tous nos systèmes à débordement.



AHORRO DE TIEMPO, MANO DE OBRA Y RECURSOS

SAVINGS IN TIME, LABOR AND RESOURCES

ÉCONOMISER DU TEMPS, DE LA MAIN-D'ŒUVRE ET DES RESSOURCES



EL SISTEMA DE COLOCACIÓN REDUCE LA CREACIÓN DE RESIDUOS

PLACEMENT SYSTEM REDUCES WASTE

LE SYSTÈME DE PLACEMENT RÉDUIT LA PRODUCTION DE DÉCHETS



ACABADO PERFECTO DE LA CORONACIÓN DE LA PISCINA

PERFECT FINISH FOR THE POOL COPING

FINITION PARFAITE DE LA MARGELLE DE LA PISCINE



ELIMINA LAS DEFICIENCIAS PRODUCIDAS POR EL ENCOFRADO

ELIMINATES DEFECTS CAUSED BY THE FORMWORK

ÉLIMINE LES DÉFICIENCES CAUSÉES PAR LE COFFRAGE



AUMENTA LA ESTÉTICA VISUAL Y EL BIENESTAR

ENHANCES VISUAL AESTHETICS AND COMFORT

AMÉLIORE L'ESTHÉTIQUE VISUELLE ET LE BIEN-ÊTRE



ZERO FUGAS. MÁS HIGIENE. MENOS PRODUCTOS PARA LA DEPURACIÓN

ZERO LEAKS, IMPROVED HYGIENE, FEWER PURIFICATION PRODUCTS

ZÉRO FUITE. PLUS D'HYGIÈNE. MOINS DE PRODUITS DE PURIFICATION.



ENCAJA CON LAS MÚLTIPLES PIEZAS DE ACABADO ROSA GRES

COMPATIBLE WITH A WIDE RANGE OF ROSA GRES FINISHING PIECES

S'ADAPTE AUX MULTIPLES PIÈCES DE FINITION ROSA GRES



LA CERÁMICA ROSA GRES AUMENTA EL CICLO DE VIDA DE LA PISCINA

ROSA GRES STONEWARE PROLONGS THE LIFE OF THE POOL

LA CÉRAMIQUE ROSA GRES AUGMENTE LA DURÉE DE VIE DE LA PISCINE



CONSTRUCCIÓN INDUSTRIALIZADA DE PISCINAS
 INDUSTRIALIZED POOL CONSTRUCTION
 CONSTRUCTION INDUSTRIALISÉE DE PISCINES



100% ESTANCA.
 SIN FUGAS. GARANTIZADO.

100 % WATERTIGHT.
 NO LEAKS. GUARANTEED.

100 % ÉTANCHE.
 SANS FUITE. GARANTI.



PRESUPUESTO SIN "SORPRESAS"

QUOTATION WITHOUT ANY "SURPRISES"

DEVIS "SANS SURPRISE"



MÁXIMA DURABILIDAD

MAXIMUM DURABILITY

DURABILITÉ MAXIMALE



EJECUCIÓN EN TIEMPO RÉCORD

PROJECT COMPLETION IN RECORD TIME

EXÉCUTION EN UN TEMPS RECORD



MAYOR INERCIA TÉRMICA

INCREASED THERMAL INERTIA

INERTIE THERMIQUE RENFORCÉE



MÁXIMA PRECISIÓN EN LA EJECUCIÓN

MAXIMUM PRECISION IN CONSTRUCTION

PRÉCISION MAXIMALE DANS L'EXÉCUTION



HOMOLOGACIÓN FINA GARANTIZADA

GUARANTEED FINA COMPLIANCE

HOMOLOGATION FINA GARANTIE



MENOS RECURSOS MENOS RESIDUOS

FEWER RESOURCES, LESS WASTE

MOINS DE RESSOURCES ET MOINS DE DÉCHETS

SISTEMA 10

Un innovador sistema constructivo que permite construir Piscinas Desbordantes de Hormigón mediante bloques prefabricados en un tiempo récord y con todas las garantías.

THE 10 SYSTEM

An innovative construction system that allows the construction of concrete overflow pools with prefabricated blocks in record time and with all the guarantees.

SYSTÈME 10

Un système de construction innovant qui permet de réaliser des piscines à débordement en béton à partir de blocs préfabriqués en un temps record et avec toutes les garanties.

colors & water colors

Los colores del agua
son orientativos

Water colors
are indicative



Les couleurs de l'eau
sont indicatives

Juntas de colocación
Fixcer recomendadas

Recommended Fixcer
Grouting color

Joint's d'installation
Fixcer recommandés

EUROCOLOR FLEX

-  0 | Blanco
-  8 | Gris claro
-  9 | Gris cemento
-  10 | Antracita
-  46 | Piedra
-  48 | Marrón arena

CERPOXI / PROFESSIONAL PX

-  0 | Blanco
-  2 | Beige oscuro
-  4 | Marrón claro
-  8 | Gris claro
-  9 | Gris cemento
-  10 | Antracita
-  11 | Negro
-  75 | Chocolate



Mythos Selene

48,8 x 97,9 x 1 Anti-slip
48,8 x 97,9 x 1 Liso
31 x 62,6 x 0,9 Anti-slip

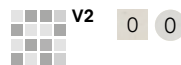

Mythos Dune

48,8 x 97,9 x 1 Anti-slip
48,8 x 97,9 x 1 Liso
31 x 62,6 x 0,9 Anti-slip



Mythos Antique

48,8 x 97,9 x 1 Anti-slip
48,8 x 97,9 x 1 Liso
31 x 62,6 x 0,9 Anti-slip

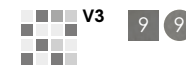

Liso = Smooth = Lisse



Iconic White

48,8 x 97,9 x 1 Anti-slip
48,8 x 97,9 x 1 Liso
31 x 62,6 x 0,9 Anti-slip
31 x 62,6 x 0,9 Pastilla

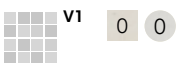

Iconic Grey

48,8 x 97,9 x 1 Anti-slip
48,8 x 97,9 x 1 Liso
31 x 62,6 x 0,9 Anti-slip
31 x 62,6 x 0,9 Pastilla



Iconic Dark

48,8 x 97,9 x 1 Anti-slip
48,8 x 97,9 x 1 Liso
31 x 62,6 x 0,9 Anti-slip
31 x 62,6 x 0,9 Pastilla



Trésor Bali

31 x 62,6 x 0,9 Anti-slip
31,3 x 31,3 Mosaic Anti-slip



Trésor Java

31 x 62,6 x 0,9 Anti-slip
31,3 x 31,3 Mosaic Anti-slip



colors & water colors

Los colores del agua
son orientativos

Water colors
are indicative

Les couleurs de l'eau
sont indicatives

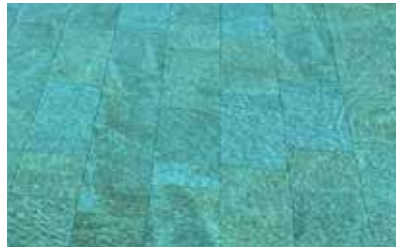

Pietro White

48,8 x 97,9 x 1 Anti-slip
31 x 62,6 x 0,9 Anti-slip
31 x 62,6 x 0,9 Pastilla



Pietro Golden

48,8 x 97,9 x 1 Anti-slip
31 x 62,6 x 0,9 Anti-slip
31 x 62,6 x 0,9 Pastilla



Pietro Grey

48,8 x 97,9 x 1 Anti-slip
31 x 62,6 x 0,9 Anti-slip
31 x 62,6 x 0,9 Pastilla



Pietro Dark

48,8 x 97,9 x 1 Anti-slip
31 x 62,6 x 0,9 Anti-slip
31 x 62,6 x 0,9 Pastilla



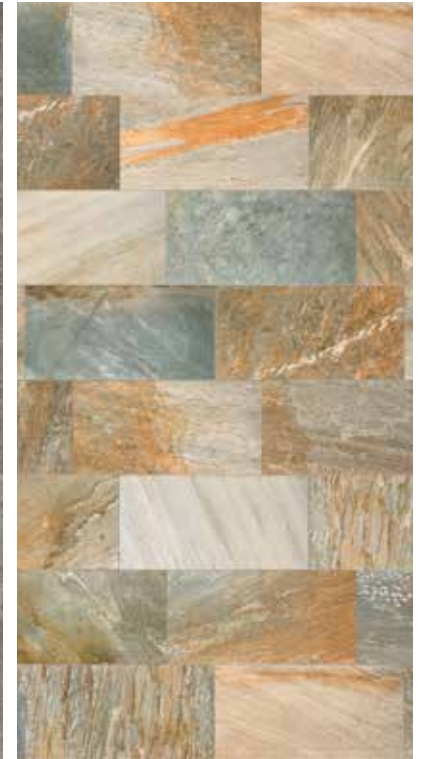

Serena Bianco

31 x 62,6 x 0,9 Anti-slip

Serena Ocra

31 x 62,6 x 0,9 Anti-slip

Serena Griggio

31 x 62,6 x 0,9 Anti-slip

Serena Nero

31 x 62,6 x 0,9 Anti-slip

Serena Mix

31 x 62,6 x 0,9 Anti-slip

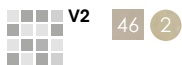

colors & water colors

Los colores del agua
son orientativos

Water colors
are indicative

Les couleurs de l'eau
sont indicatives



Mystery White

48,8 x 97,9 x 1 Anti-slip
48,8 x 97,9 x 1 Liso
31 x 62,6 x 0,9 Anti-slip
31 x 62,6 x 0,9 Liso
31,3 x 31,3 Mosaic Anti-slip

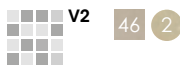

Mystery Sand

48,8 x 97,9 x 1 Anti-slip
48,8 x 97,9 x 1 Liso
31 x 62,6 x 0,9 Anti-slip
31 x 62,6 x 0,9 Liso
31,3 x 31,3 Mosaic Anti-slip



Mystery Grey

48,8 x 97,9 x 1 Anti-slip
48,8 x 97,9 x 1 Liso
31 x 62,6 x 0,9 Anti-slip
31 x 62,6 x 0,9 Liso
31,3 x 31,3 Mosaic Anti-slip



Mystery Blue Stone

48,8 x 97,9 x 1 Anti-slip
48,8 x 97,9 x 1 Liso
31 x 62,6 x 0,9 Anti-slip
31 x 62,6 x 0,9 Liso
31,3 x 31,3 Mosaic Anti-slip



Liso = Smooth = Lisse

Mosaico Emallado = Mesh-mounted Mosaic = Mosaïque Émaux



Wood texture



Stela White

19,4 x 97,9 x 1 Anti-slip
19,4 x 97,9 x 1 Liso



Stela Golden

19,4 x 97,9 x 1 Anti-slip
19,4 x 97,9 x 1 Liso

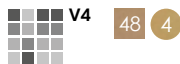

Stela Grey

19,4 x 97,9 x 1 Anti-slip
19,4 x 97,9 x 1 Liso



Stela Dark

19,4 x 97,9 x 1 Anti-slip
19,4 x 97,9 x 1 Liso



wo od tex tu re



Alma Pure

19,4 x 97,9 x 1 Anti-slip
19,4 x 97,9 x 1 Liso

Alma Honey

19,4 x 97,9 x 1 Anti-slip
19,4 x 97,9 x 1 Liso

Alma Forest

19,4 x 97,9 x 1 Anti-slip
19,4 x 97,9 x 1 Liso

Alma Mist

19,4 x 97,9 x 1 Anti-slip
19,4 x 97,9 x 1 Liso



constructive systems



Sistema desbordante
Deck level pool system
Système à débordement

Prestige



Sistema desbordante
Deck level pool system
Système à débordement

Slim



Sistema desbordante
Deck level pool system
Système à débordement

Smart



Sistema desbordante
Deck level pool system
Système à débordement

Zen

constructive systems



Solución Piscina Infinity
Infinity Pool Solution
Solution Piscine Infinity



Sistema Skimmer, solución «L»
Skimmer System, «L» solution
Système Skimmer, solution «L»



Sistema Skimmer, solución «S»
Skimmer System, «S» solution
Système Skimmer, solution «S»



New Look System
New Look System
New Look System

Prestige

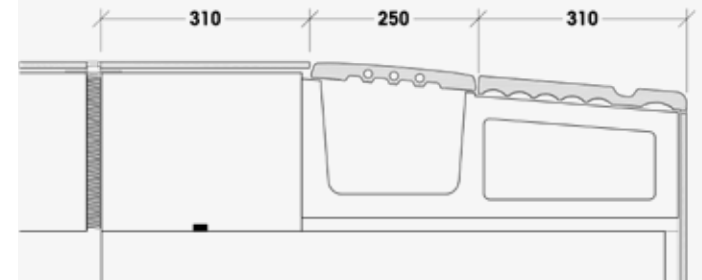
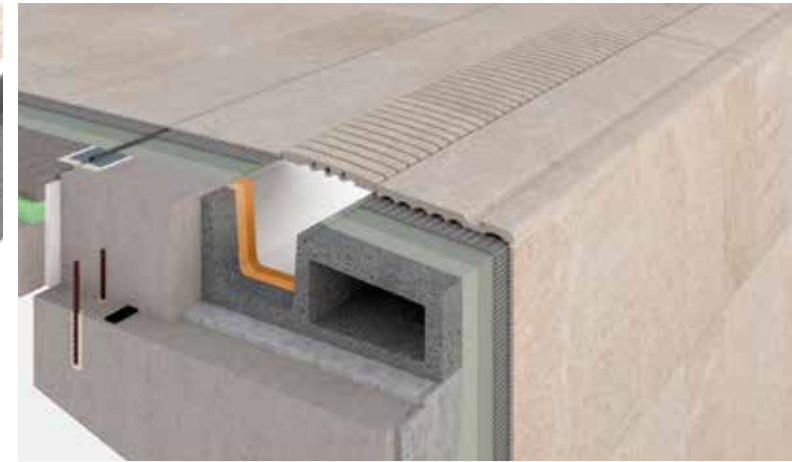
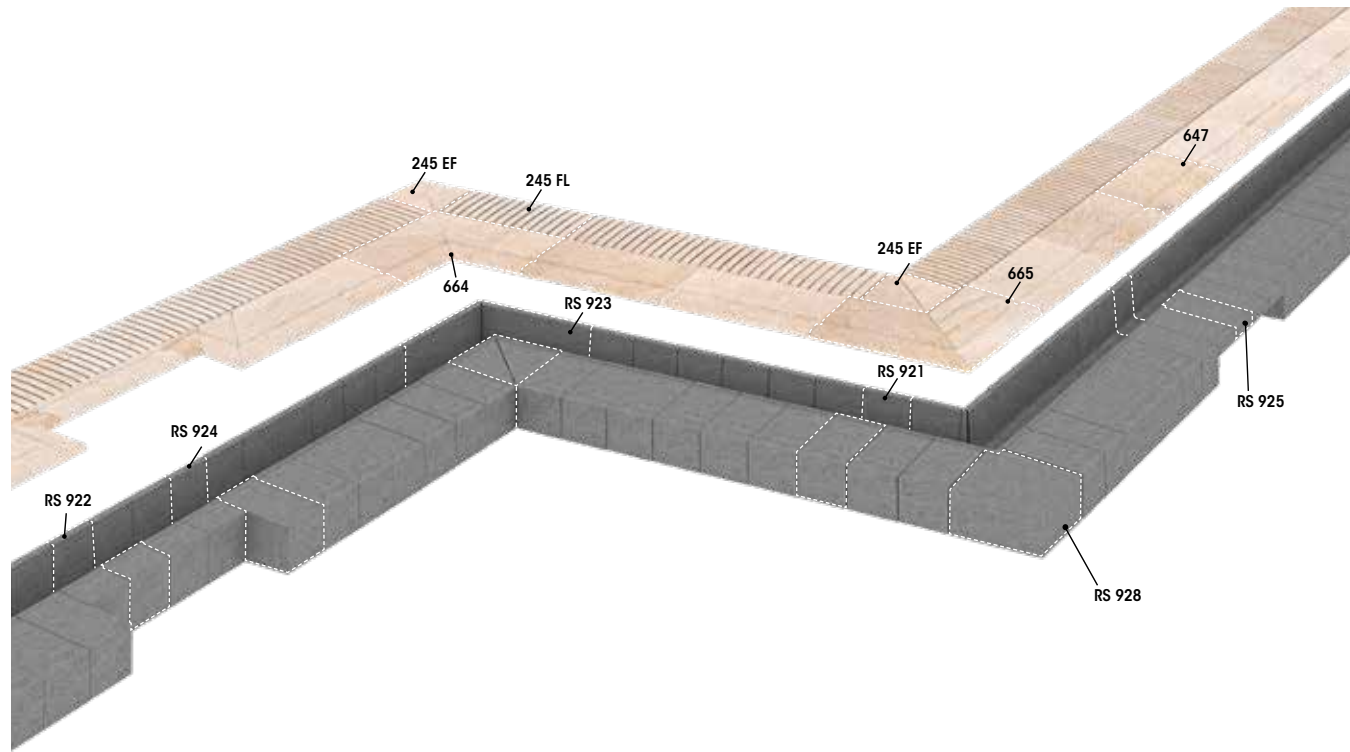

Bloques S9 | S9 Blocks | Modules S9

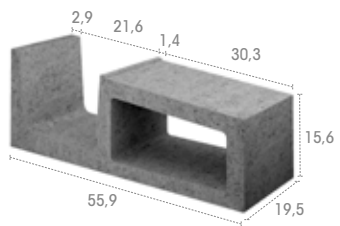

RS 921

Base

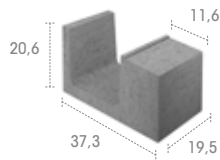

RS 922

Escalera abierta
Open built-in stairs
Échelle ouverte

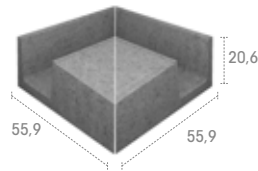

RS 923

Esquina interior
Inside corner
Angle intérieur

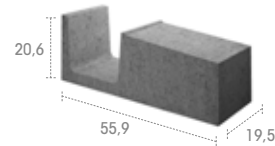

RS 924

Maciza
Solid
Solide

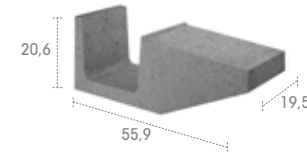

RS 925

Escalera cerrada
Closed built-in stairs
Échelle fermée

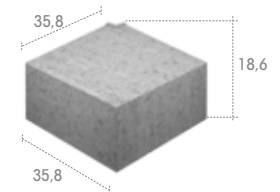

RS 928

Esquina exterior
Outside corner
Angle extérieur

Sistema de pre-playa descendente solucionado con la ref. 647 de 31 x 62,7 cm. Los bloques S9 generan la pendiente y funcionan como punto de apoyo para la rejilla del rebosadero.

Downward sloping pre-deck system using ref. 647 measuring 31 x 62.7 cm. S9 blocks provide the slope and support the overflow grate.

Système de débordement avant plage avec pente vers bassin avec la réf. 647 de 31 x 62,7 cm. Les blocs S9 génèrent la pente et servent de point d'appui à la grille de débordement.

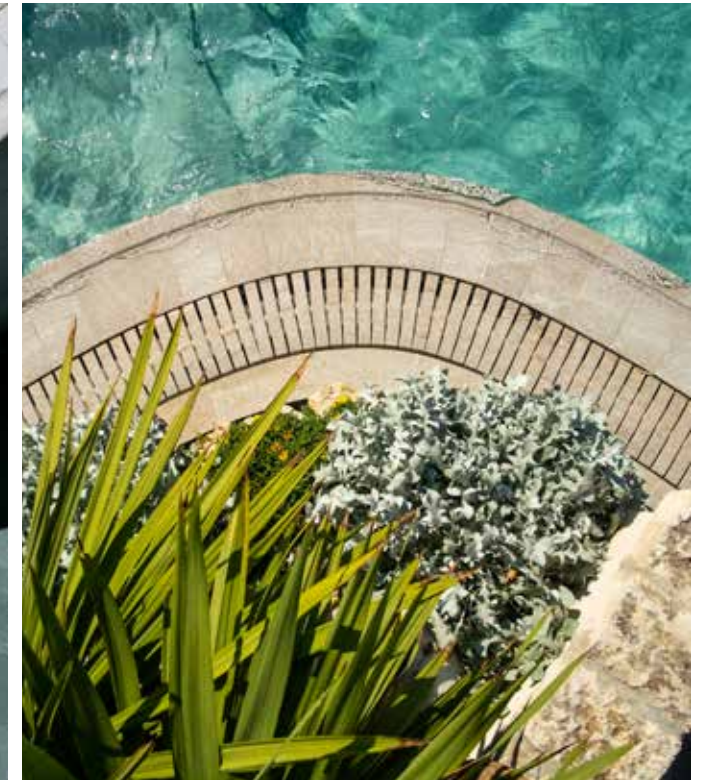
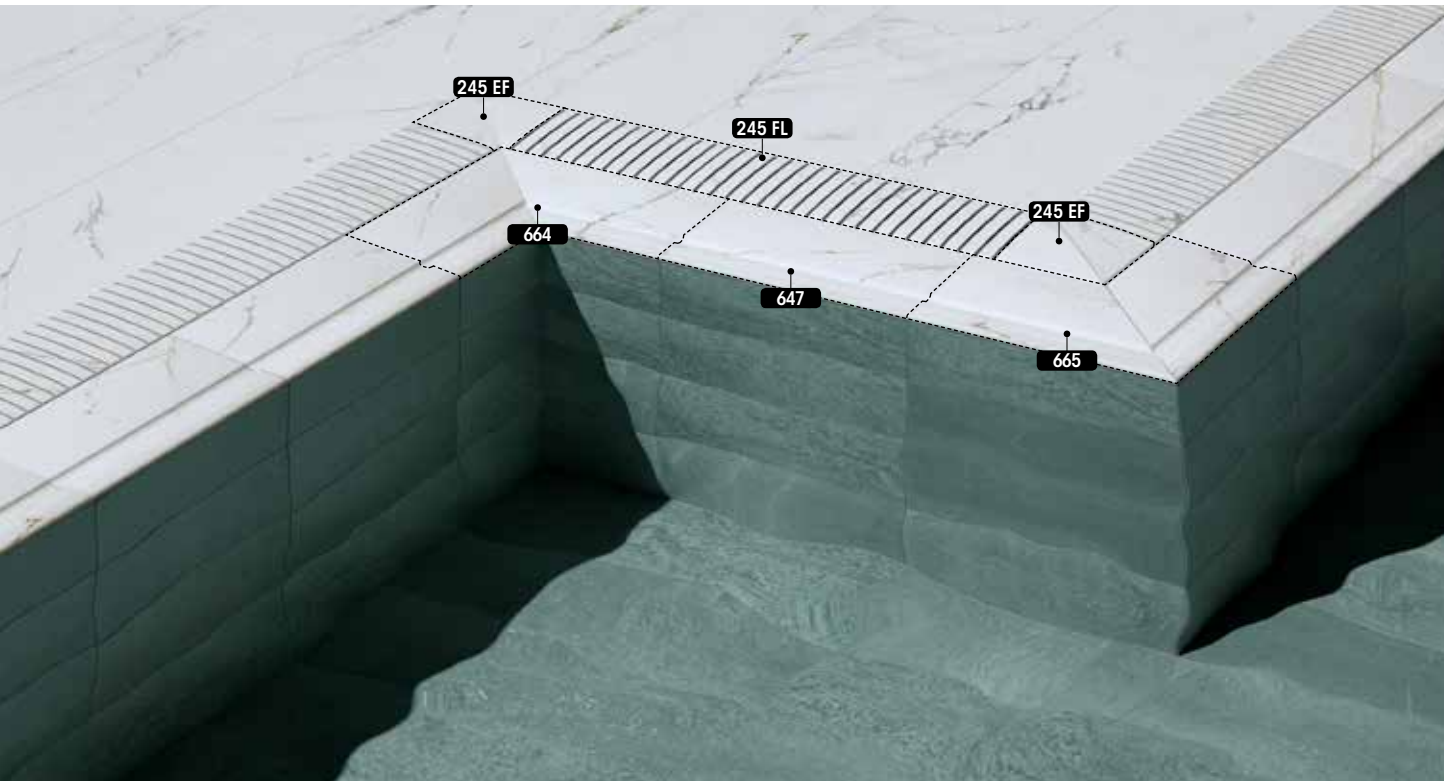

Piezas de borde | Edge tiles | Margelles  Maciza/Solid/Solide

Rejilla Flex | Flex Grid | Grille Flex

647 Anti-Slip
62,6 x 31 x 2,6



664 Anti-Slip
62,6 x 62,6 x 2,6

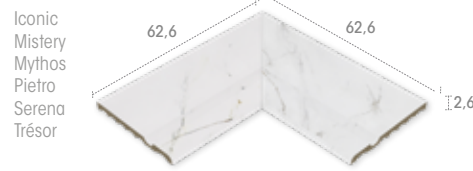

665 Anti-Slip
62,6 x 62,6 x 2,6

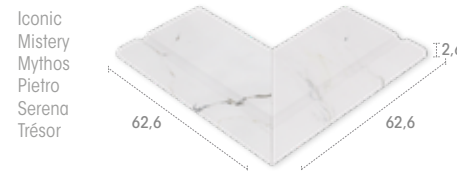

245 FL Anti-Slip
49,5 x 24,5 x 2,2

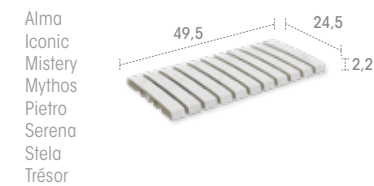

245 EF Anti-Slip
26,6 x 26,6 x 2,2

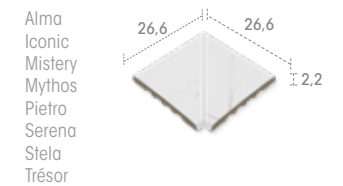

Slim

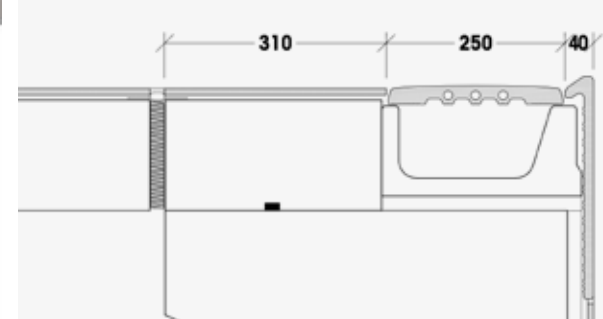
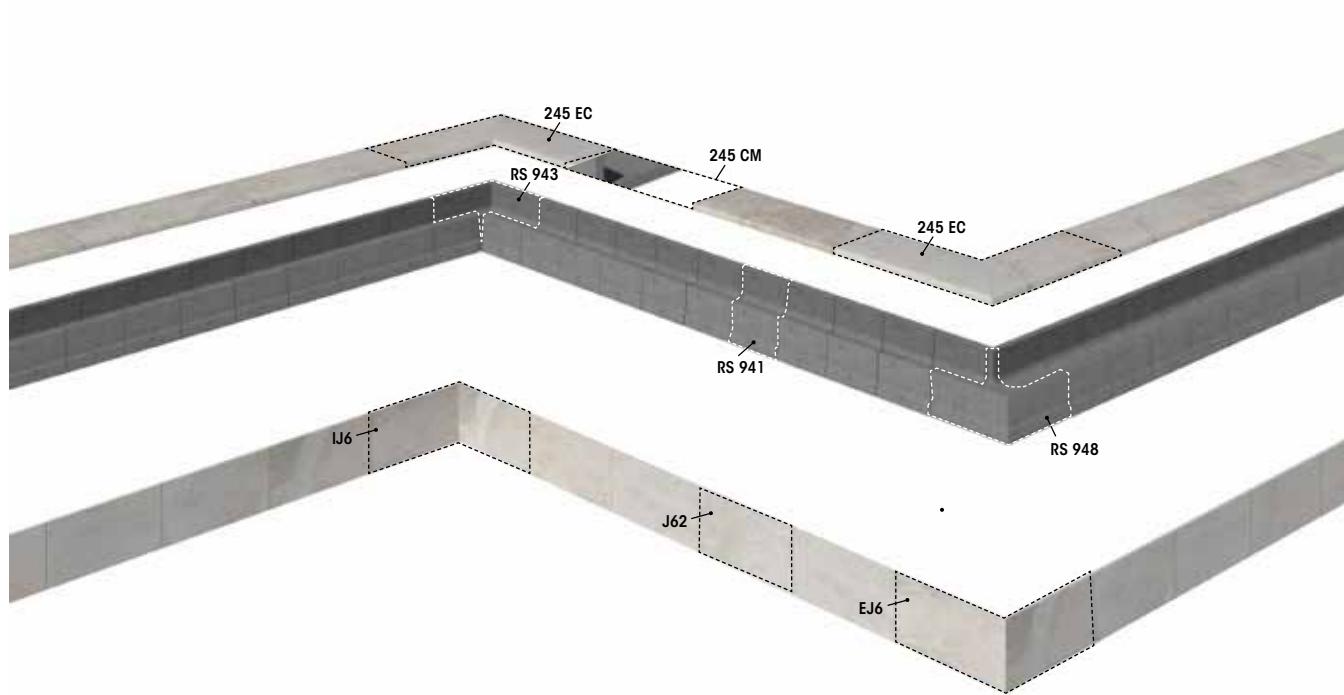

Bloques S9 | S9 Blocks | Modules S9

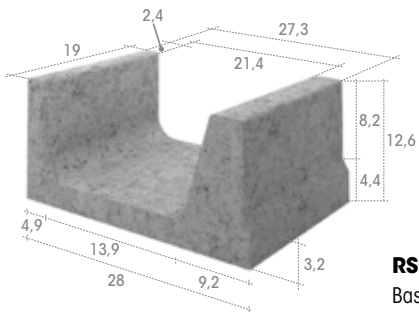

RS 941
Base

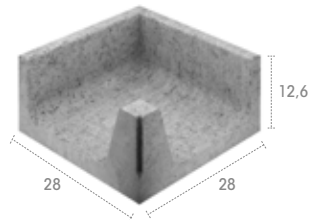

RS 943
Esquina interior
Inside corner
Angle intérieur

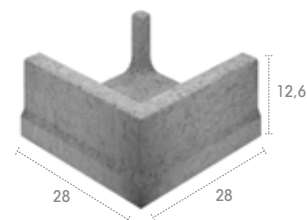

RS 948
Esquina exterior
Outside corner
Angle extérieur

La innovación del Sistema Slim soluciona los proyectos de piscinas desbordantes con playas estrechas de forma práctica y funcional. Su diseño sitúa el nivel del agua por encima del nivel de la playa. Consigue recrear un bonito efecto espejo.

The innovative Slim System is a practical and functional solution for overflow pool projects with limited deck space. The design places the water level above the deck, creating an attractive mirror effect.

L'innovation du Système Slim apporte une solution pratique et fonctionnelle aux projets de piscine à débordement avec un espace de plage réduit. Sa conception situe le niveau de l'eau au-dessus du niveau de la plage et permet de créer un très joli effet miroir.

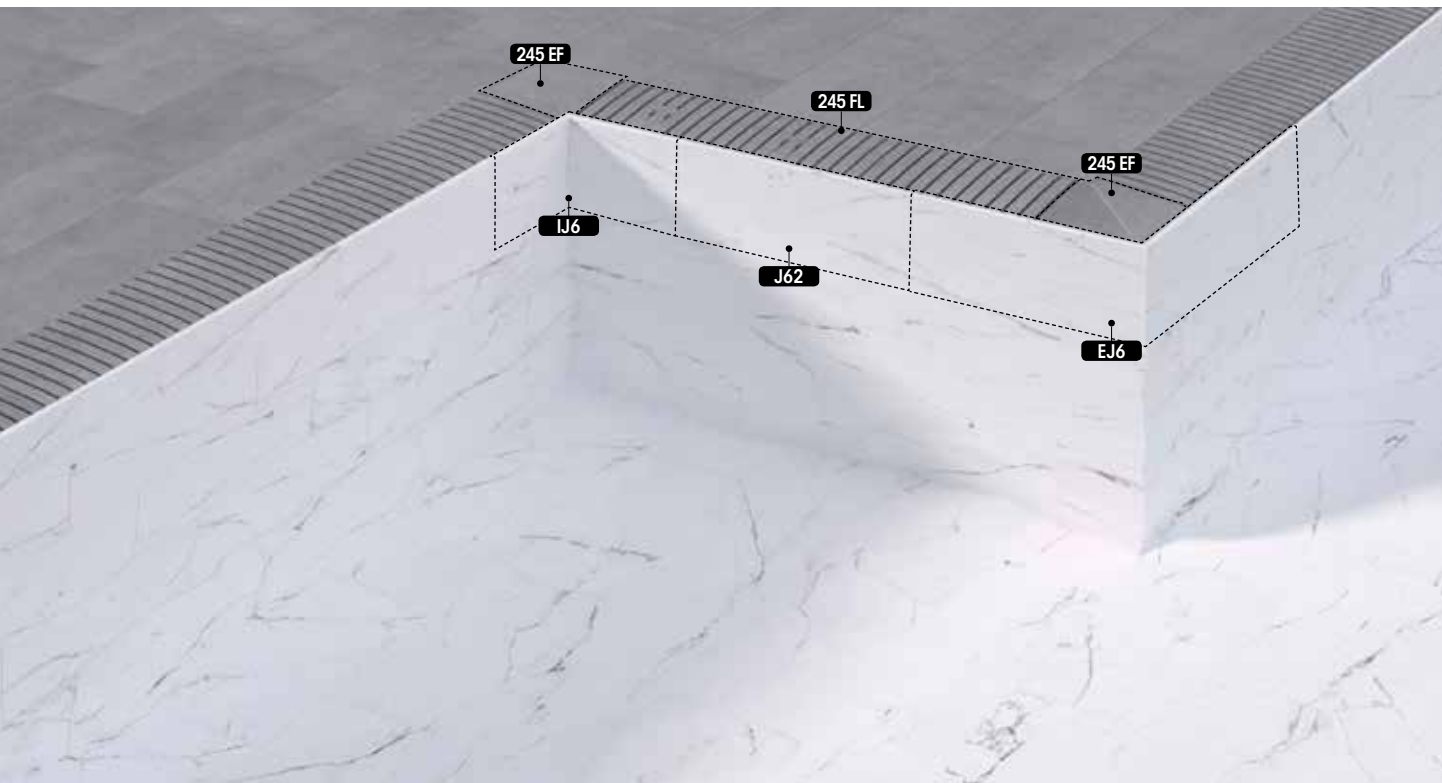

Piezas de borde | Edge tiles | Margelles  Maciza/Solid/Solide

Rejilla Flex | Flex Grid | Grille Flex

J62 Anti-Slip
62,6 x 31 x 3,8

Iconic
Mistery
Mythos
Pietro
Serena
Trésor

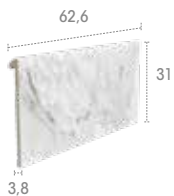

IJ6 Anti-Slip
31 x 31 x 31

Iconic
Mistery
Mythos
Pietro
Serena
Trésor

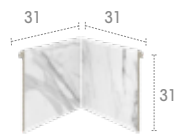

EJ6 Anti-Slip
62,6 x 62,6 x 31

Iconic
Mistery
Mythos
Pietro
Serena
Trésor

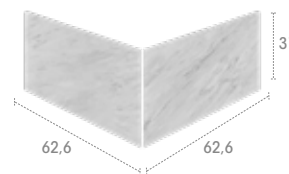

245 FL Anti-Slip
49,5 x 24,5 x 2,2

Alma
Iconic
Mistery
Mythos
Pietro
Serena
Stela
Trésor

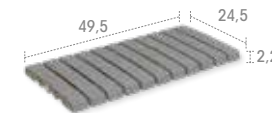

245 EF Anti-Slip
26,6 x 26,6 x 2,2

Alma
Iconic
Mistery
Mythos
Pietro
Serena
Stela
Trésor

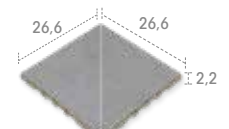

Smart

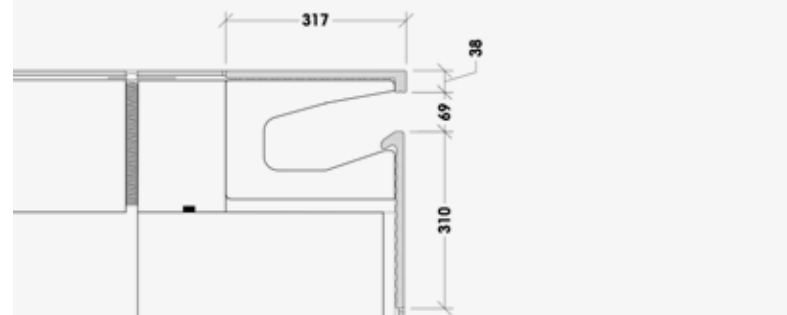
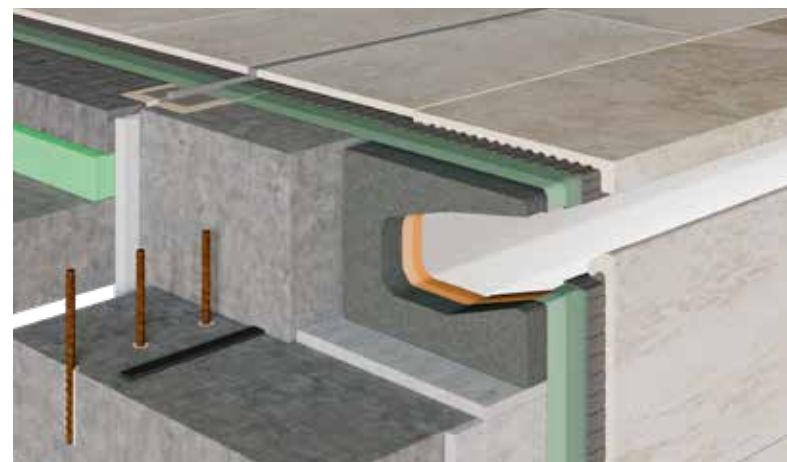
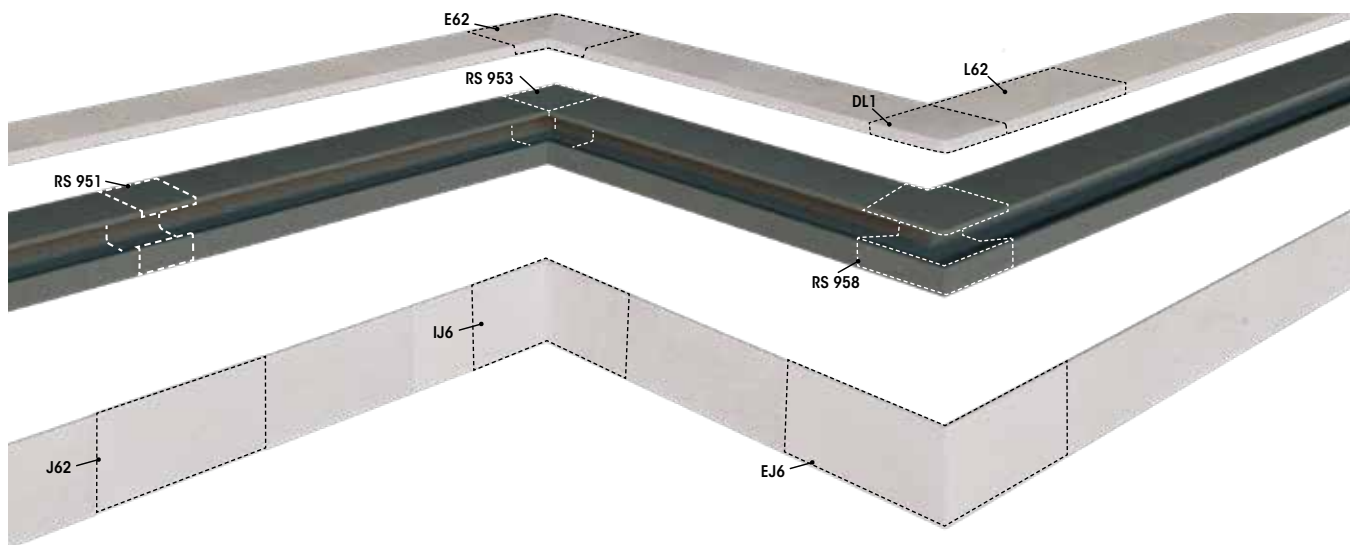

Bloques S9 | S9 Blocks | Modules S9

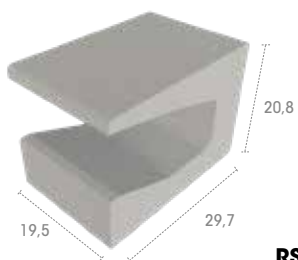

RS 951
Base

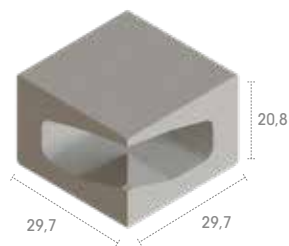

RS 953
Esquina interior
Inside corner
Angle intérieur

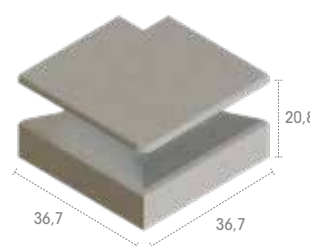

RS 958
Esquina exterior
Outside corner
Angle extérieur

Sistema desbordante longitudinal oculto. Su innovación hace posible que el nivel del agua se sitúe por debajo del nivel de la playa. De esta forma se evita que el agua salga de la piscina. Su diseño ofrece un buen agarre del bañista.

Hidden longitudinal overflow system that allows the water level to remain below deck level. This prevents water from spilling out of the pool. The design also provides a handhold for swimmers.

Il s'agit d'un système à débordement longitudinal invisible. Il permet de maintenir le niveau de l'eau en-dessous de la plage. Il empêche ainsi l'eau de déborder hors de la piscine. Il est conçu de telle façon que les nageurs peuvent s'y agripper commodément.



Piezas de borde | Edge tiles | Margelles  Maciza/Solid/Solide

J62 Anti-Slip
62,6 x 31 x 3,8

Iconic
Mistery
Mythos
Pietro
Serena
Trésor

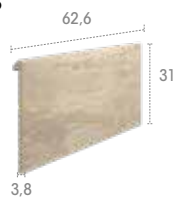

IJ6 Anti-Slip
31 x 31 x 31

Iconic
Mistery
Mythos
Pietro
Serena
Trésor

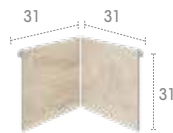

EJ6 Anti-Slip
62,6 x 62,6 x 31

Iconic
Mistery
Mythos
Pietro
Serena
Trésor

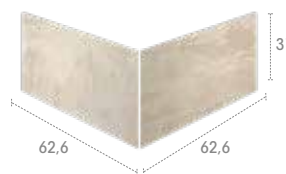

Zen

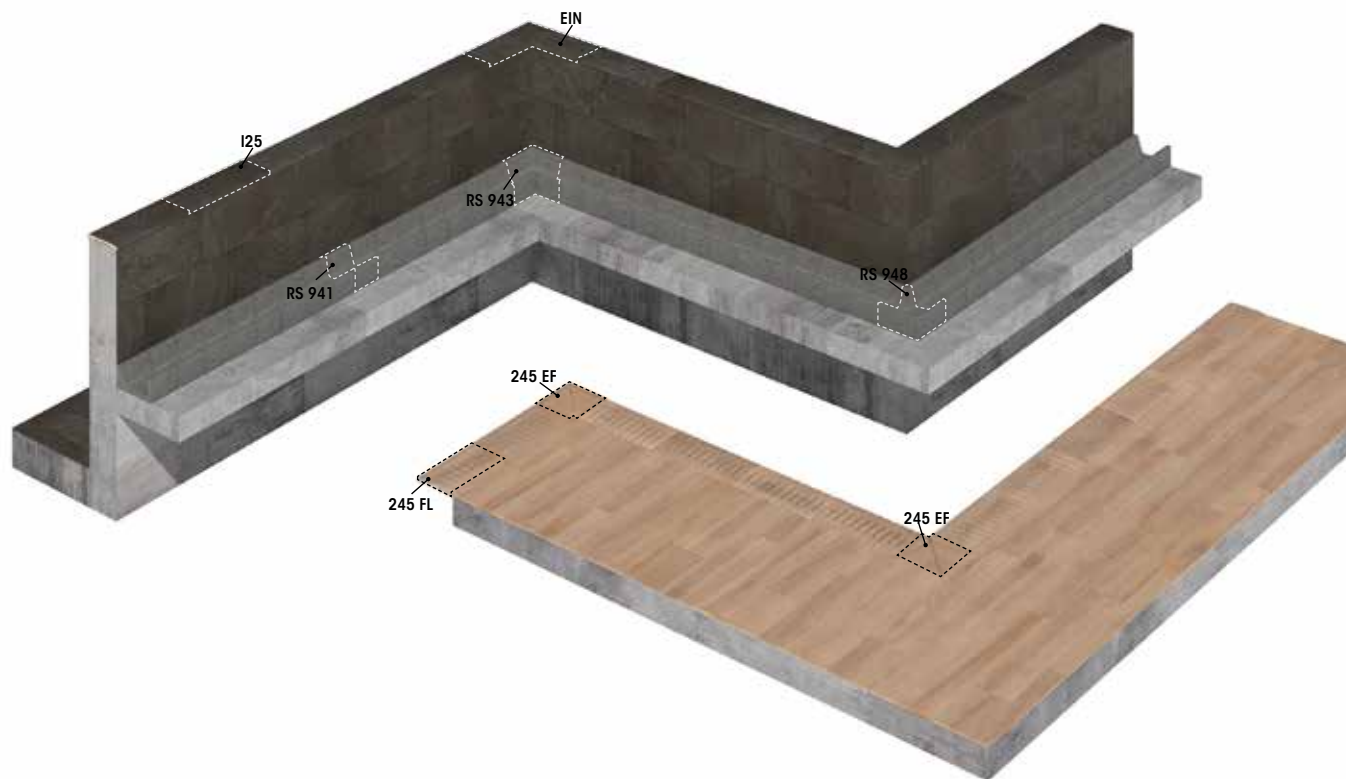

Bloques S9 | S9 Blocks | Modules S9

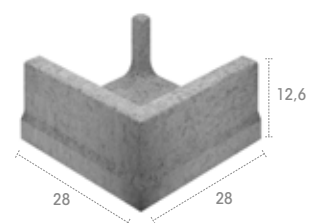
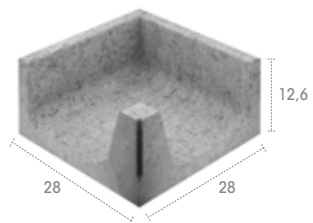
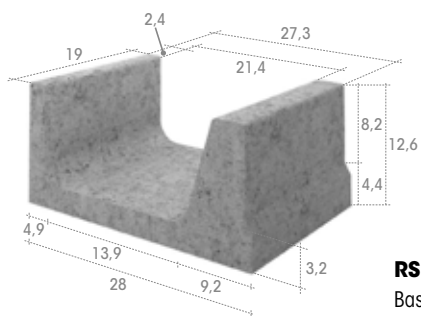

Piscina con desborde perimetral elevado sobre un canal oculto empotrado en la playa. El Sistema Zen es perfecto para construir una original piscina de inspiración balinesa.

Pool with raised perimeter overflow above a hidden channel integrated into the deck. The Zen System is perfect for building an original Balinese-inspired pool.

Piscine à débordement périmétrique surélevé au-dessus d'un canal invisible intégré dans la plage. Le Système Zen est parfait pour construire une piscine originale d'inspiration balinaise.



Piezas de borde | Edge tiles | Margelles

I25 Anti-Slip

62,6 x 24,5 x 2,2

- Alma
- Iconic
- Mistery
- Mythos
- Pietro
- Serena
- Stela
- Trésor

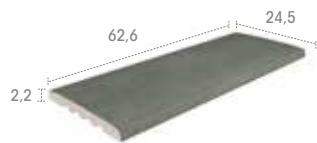

EIN Anti-Slip

62,6 x 62,6 x 2,2

- Alma
- Iconic
- Mistery
- Mythos
- Pietro
- Serena
- Stela
- Trésor

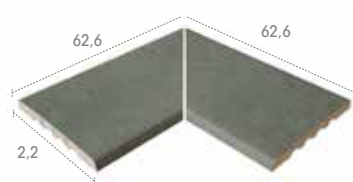

Flex



Su estructura en forma de trapecio evita el puente de agua incluso cuando está mal colocada. Facilita la reposición de piezas sueltas. Permite realizar curvas a partir de un radio de 75 cm.

Trapezoidal structure allows for perfect water flow even when poorly laid. Loose pieces can be easily repositioned. It can be used to create curves with a radius of more than 75 cm.

Sa structure trapézoïdale permet une parfaite évacuation de l'eau. La mise en place de pièces de remplacement est simplifiée. Permet de réaliser des courbes à partir d'un rayon de 75 cm.



Piezas | Pieces | Pièces

245 FL Anti-Slip

49,5 x 24,5 x 2,2

Alma
Iconic
Mistery
Mythos
Pietro
Serena
Stela
Trésor



245 EF Anti-Slip

26,6 x 26,6 x 2,2

Alma
Iconic
Mistery
Mythos
Pietro
Serena
Stela
Trésor



Compact



Consiste en una sola pieza fabricada sin adhesivos. Al colocarla queda totalmente integrada con el borde. El desagüe se realiza a través de un sistema de orificios laterales apenas visible y con una capacidad óptima.

Composed of a single piece, without adhesives. Once in place, it blends in perfectly with the edge of the pool. The water is drained through side openings that are barely visible and have optimal capacity.

Elle consiste en une seule pièce, conçue sans adhésifs. Sa mise en place l'intègre totalement au débordement. Le drainage s'effectue à travers les mini canaux latéraux, à peine visibles mais d'une capacité optimale.

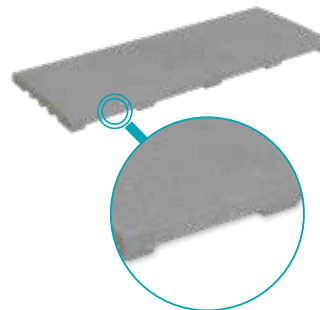

Piezas | Pieces | Pièces

245 CM Anti-Slip

62,6 x 24,5 x 2,2

Alma
Iconic
Mistery
Mythos
Pietro
Serena
Stela
Trésor



245 EC Anti-Slip

62,6 x 62,6 x 2,2

Alma
Iconic
Mistery
Mythos
Pietro
Serena
Stela
Trésor

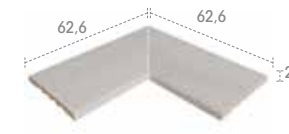



Una solución única para construir piscinas Infinity. Se trata de una pieza especial multifunción. La misma pieza sirve para revestir el murete de la piscina y el murete del canal de recogida del agua. Así conseguimos un precioso diseño integrado.

Unique solution for the construction of infinity pools. This is a special multi-purpose piece. The same piece is used to line the walls of the pool and the wall of the water collection channel. This way the edge, pool and walls all match beautifully.

Une solution unique pour la construction de piscines à débordement. Il s'agit d'une pièce spéciale multifonctionnelle. La même pièce peut être utilisée pour couvrir la paroi de la piscine et la paroi du canal de collecte de l'eau. Cela permet de créer un magnifique design intégré.



Piezas | Pieces | Pièces

I25 Anti-Slip

62,6 x 24,5 x 2,2

Alma
Iconic
Mistery
Mythos
Pietro
Serena
Stela
Trésor

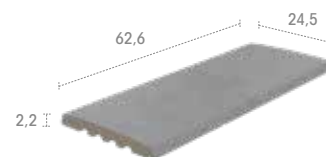

EIN Anti-Slip

62,6 x 62,6 x 2,2

Alma
Iconic
Mistery
Mythos
Pietro
Serena
Stela
Trésor

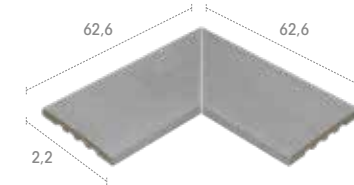

L SOLUTION



S SOLUTION

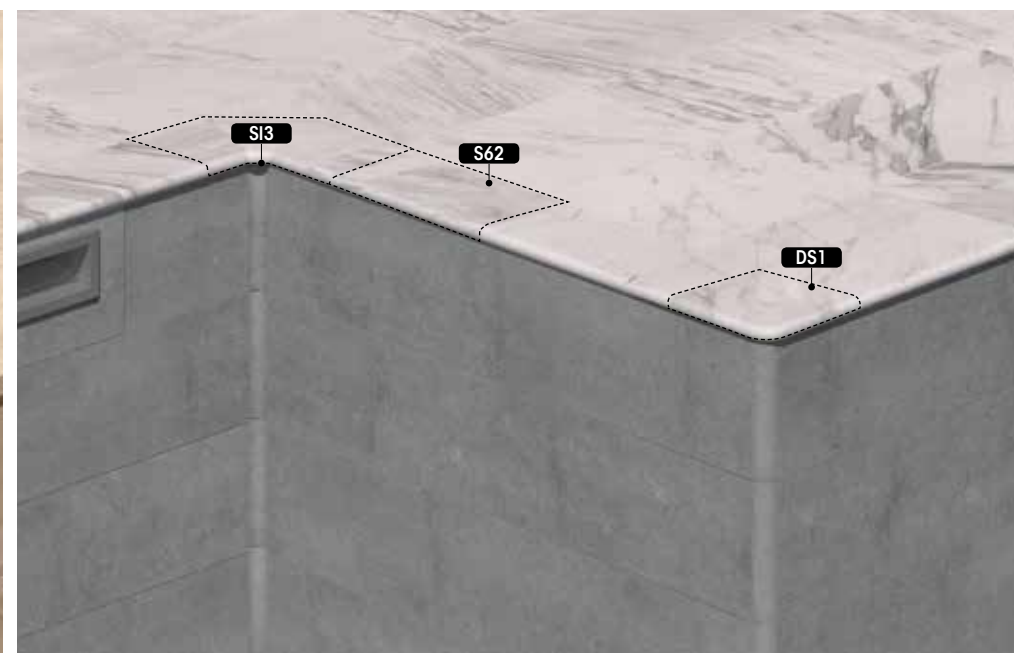

L62 Anti-Slip

62,6 x 31,7 x 3,8

Alma
Iconic
Mistery
Mythos
Pietro
Serena
Stela
Trésor



L98 Anti-Slip

97,9 x 31,7 x 3,8

Alma
Iconic
Mistery
Mythos
Pietro
Serena
Stela



E62 Anti-Slip

62,6 x 62,6 x 3,8

Alma
Iconic
Mistery
Mythos
Pietro
Serena
Stela
Trésor



DL1 Anti-Slip

31,7 x 31,7 x 3,8

Iconic
Mistery
Mythos
Pietro
Serena
Trésor

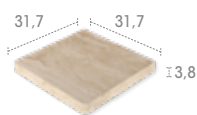

DL2 Anti-Slip

31,7 x 31,7 x 3,8

Alma
Iconic
Mistery
Mythos
Pietro
Serena
Stela
Trésor

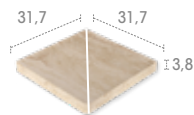

S62 Anti-Slip

62,6 x 31 x 2,6

Alma
Iconic
Mistery
Mythos
Pietro
Serena
Stela

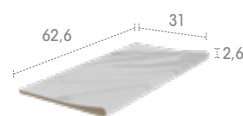

S13 Anti-Slip

46 x 46 x 2,6

Alma
Iconic
Mistery
Mythos
Pietro
Serena
Stela

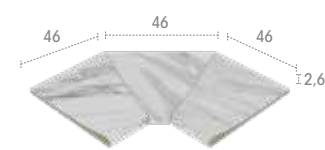

SE3 Anti-Slip

31 x 31 x 2,6

Alma
Iconic
Mistery
Mythos
Pietro
Serena
Stela

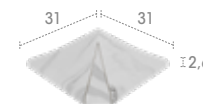

DS1 Anti-Slip

31 x 31 x 2,6

Alma
Iconic
Mistery
Mythos
Pietro
Serena
Stela



new look system

SOLUCIÓN REHABILITACIÓN PISCINAS

El nuevo sistema para rehabilitar piscinas antiguas con gres porcelánico de alta calidad.

POOL RENOVATION SOLUTION

A new system for renovating the old pools with high-quality porcelain stoneware.

SOLUTION RÉNOVATION PISCINES

Le nouveau système pour rénover les anciennes piscines avec du grès cérame de haute qualité.

Piezas esmaltadas a 3 caras.

Pieces glazed on 3 sides.

Pièces émaillées sur 3 faces.



Dos formatos de borde con un ancho de 50 cm. La dimensión perfecta para lograr una sustitución sencilla y eficaz en la mayoría de piscinas antiguas.

Two edge formats with a width of 50 cm. The perfect size for simple and effective replacement in most old pools.

Deux formats de bordure de 50 cm de large. La dimension parfaite pour un remplacement simple et efficace pour la plupart des piscines anciennes.



Antes / Before / Avant



Después / After / Après



Antes / Before / Avant



Después / After / Après

Piezas de borde y acabados en curva | Edging tiles and curved finishes | Margelles et finitions incurvées

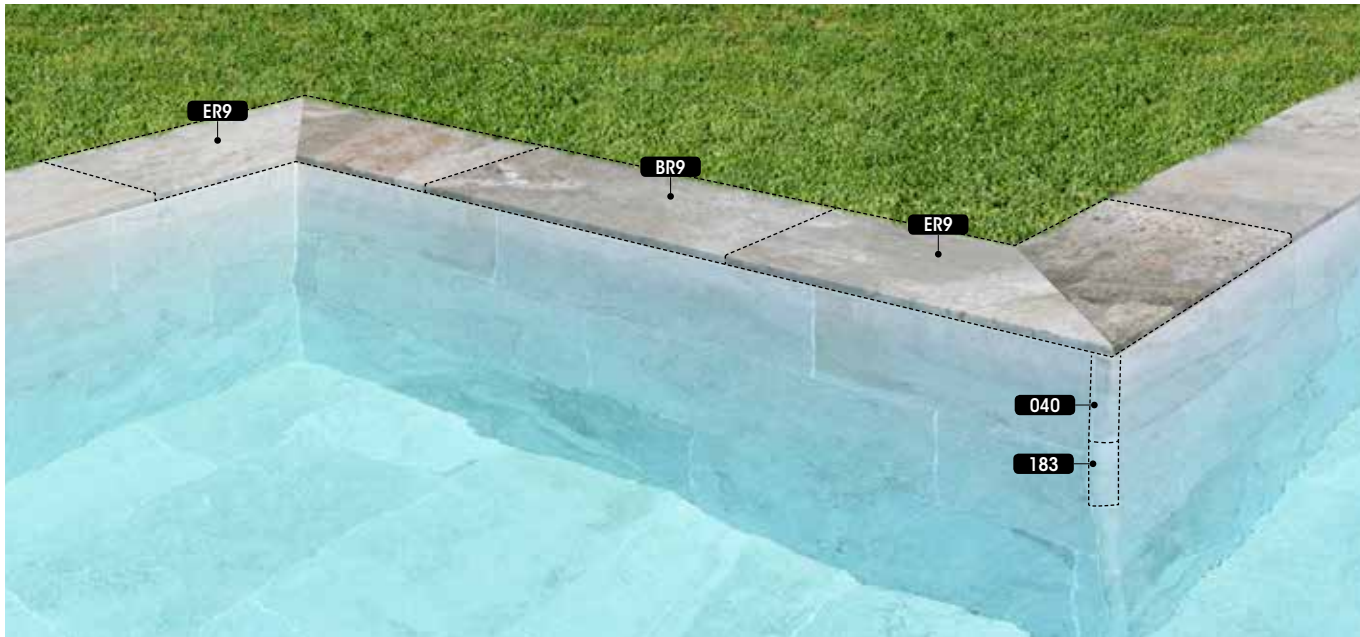

BR6 Anti-Slip
62,6 x 50 x 2,6

- Iconic White
- Mystery White
- Mystery Grey
- Mystery Blue stone
- Mythos Dune
- Pietro White
- Pietro Golden
- Pietro Grey
- Pietro Dark
- Serena Ocra



ER6 Anti-Slip
62,6 x 62,6 x 50 x 2,6

- Iconic White
- Mystery White
- Mystery Grey
- Mystery Blue stone
- Mythos Dune
- Pietro White
- Pietro Golden
- Pietro Grey
- Pietro Dark
- Serena Ocra



BR9 Anti-Slip
97,9 x 50 x 2,6

- Iconic White
- Mystery White
- Mystery Grey
- Mystery Blue stone
- Mythos Dune
- Pietro White
- Pietro Golden
- Pietro Grey
- Pietro Dark
- Alma Forest



ER9 Anti-Slip
97,9 x 97,9 x 50 x 2,6

- Iconic White
- Mystery White
- Mystery Grey
- Mystery Blue stone
- Mythos Dune
- Pietro White
- Pietro Golden
- Pietro Grey
- Pietro Dark
- Alma Forest



056
62,6 x 5 x 0,9

- Iconic
- Mystery
- Mythos
- Pietro
- Serena
- Trésor

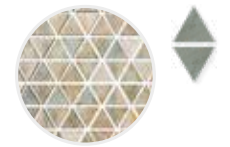

E56
5 x 4,3 x 0,9

- Iconic
- Mystery
- Mythos
- Pietro
- Serena
- Trésor

- Material suministrado sin enmallar
- Material supplied unmeshed
- Matériau fourni non maillé

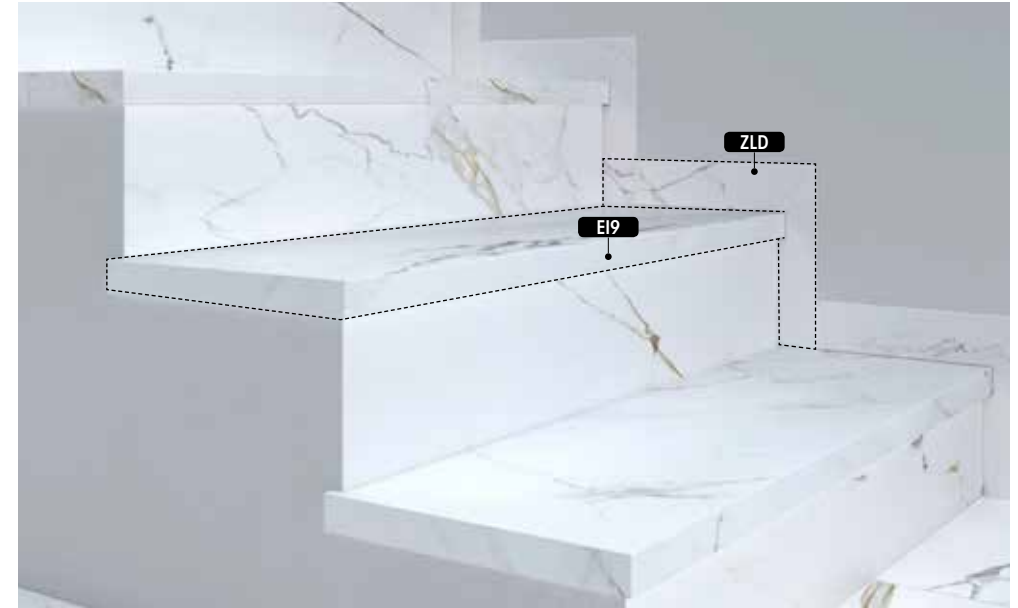
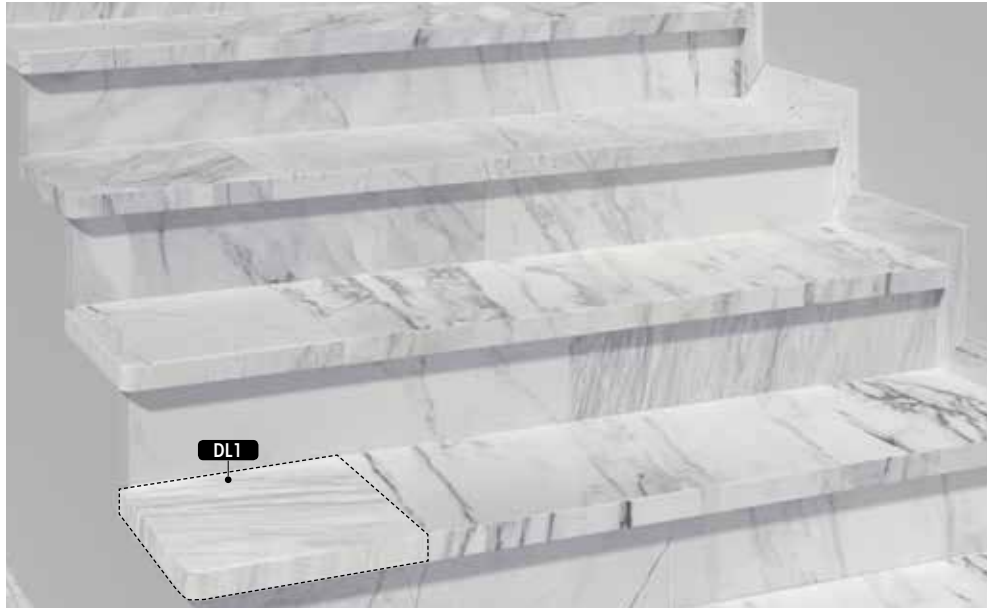

L98 Anti-Slip

97,9 x 31,7 x 3,8

Alma
Iconic
Mistery
Mythos
Pietro
Stela



L62 Anti-Slip

62,6 x 31,7 x 3,8

Alma
Iconic
Mistery
Mythos
Pietro
Serena
Stela
Trésor

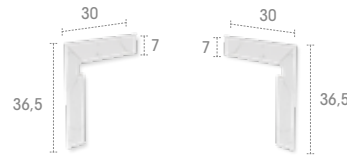
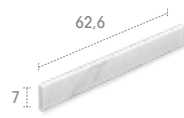
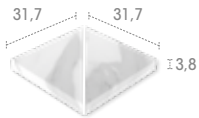
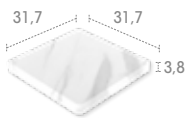
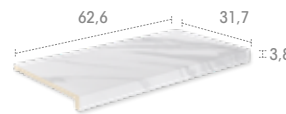

E19 Anti-Slip

97,9 x 31,7 x 3,8

Alma
Iconic
Mistery
Mythos
Pietro
Stela



ED9 Anti-Slip

97,9 x 31,7 x 3,8

Alma
Iconic
Mistery
Mythos
Pietro
Stela

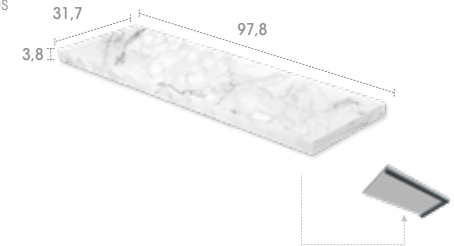

DL1 Anti-Slip

31,7 x 31,7 x 3,8

Iconic
Mistery
Mythos
Pietro
Serena
Trésor

DL2 Anti-Slip

31,7 x 31,7 x 3,8

Alma
Iconic
Mistery
Mythos
Pietro
Serena
Stela
Trésor

Z62

62,6 x 7

Alma
Iconic
Mistery
Mythos
Pietro
Serena
Stela
Trésor

ZLI

36,5 x 30 x 7

Alma
Iconic
Mistery
Mythos
Pietro
Serena
Stela
Trésor

ZLD

36,5 x 30 x 7

Alma
Iconic
Mistery
Mythos
Pietro
Serena
Stela
Trésor

E16 Anti-Slip

62,6 x 31,7 x 3,8

Alma
Iconic
Mistery
Mythos
Pietro
Serena
Stela
Trésor

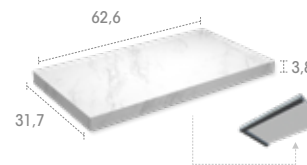

ED6 Anti-Slip

62,6 x 31,7 x 3,8

Alma
Iconic
Mistery
Mythos
Pietro
Serena
Stela
Trésor

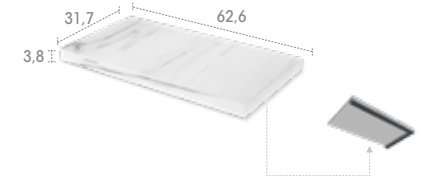

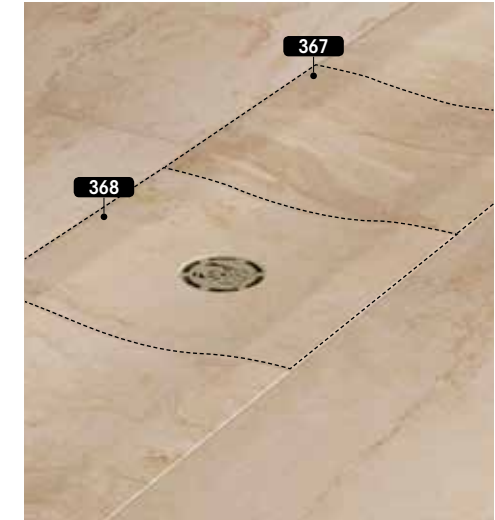
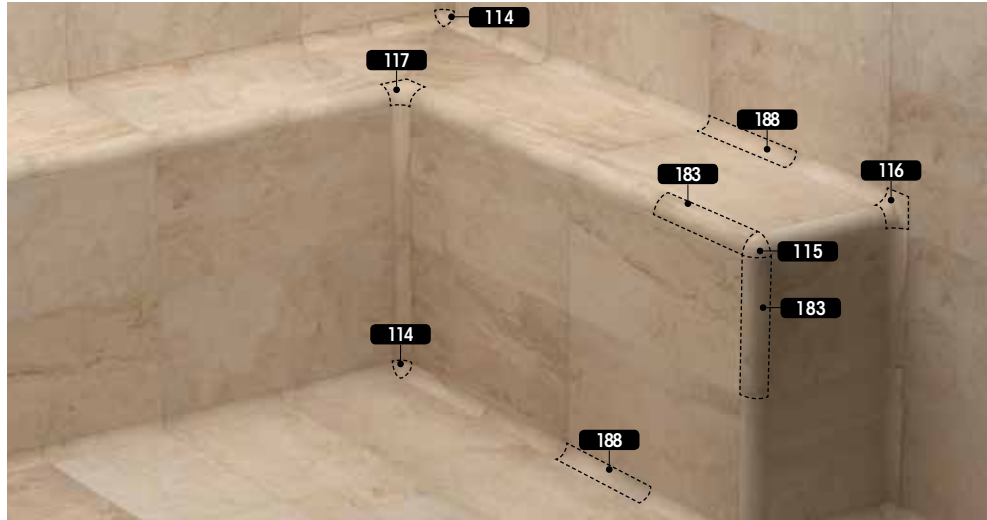

188 Anti-Slip

31 x 4 x 4

Iconic
Mistery
Mythos
Pietro
Serena
Trésor

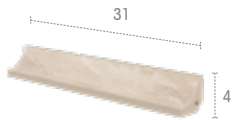

183 Anti-Slip

31 x 4 x 4

Iconic
Mistery
Mythos
Pietro
Serena
Trésor



147 Anti-Slip

31 x 4 x 4

Iconic
Mistery
Mythos
Pietro
Serena
Trésor



121 CM Anti-Slip

62,6 x 12,5 x 2,2

Alma
Iconic
Mistery
Mythos
Pietro
Serena
Stela
Trésor

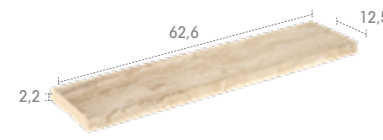

367 Anti-Slip

31 x 31 x 2,4

Alma
Iconic
Mistery
Mythos
Pietro
Serena
Stela
Trésor



114 Anti-Slip

4 x 4

Iconic
Mistery
Mythos
Pietro
Serena
Trésor



115 Anti-Slip

4 x 4

Iconic
Mistery
Mythos
Pietro
Serena
Trésor



116 Anti-Slip

4 x 4

Iconic
Mistery
Mythos
Pietro
Serena
Trésor



117 Anti-Slip

4 x 4

Iconic
Mistery
Mythos
Pietro
Serena
Trésor



CRA C1

50 x 13 x 7,5



DCR C1



CCR C1



TCR C1



368 Anti-Slip

31 x 31 x 2,4

Alma
Iconic
Mistery
Mythos
Pietro
Serena
Stela
Trésor

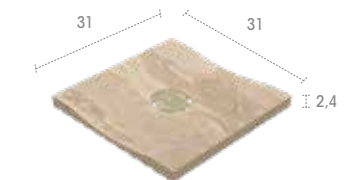

030 Anti-Slip

31 x 4 x 4

Iconic
Mistery
Mythos
Pietro
Serena
Trésor

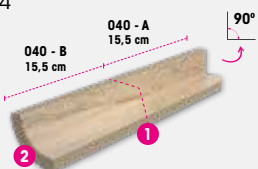

Para esquinas interiores
For inner corners
Pour angles intérieurs

040 Anti-Slip

31 x 4 x 4

Iconic
Mistery
Mythos
Pietro
Serena
Trésor



Para esquinas exteriores
For outer corners
Pour angles extérieurs

1

Radio igual a DL1 en el centro
Radius matches DL1 in the centre
Rayon égal à DL1 au centre

2

Radio: 4 cm
Radius: 4 cm
Rayon: 4 cm

En estas dos referencias, **030** y **040**, uno de los extremos acaba en un ángulo recto de 90° mientras que el otro acaba en una curva con un radio de 4 cm.

These two references, **030** and **040**, have a curve with a 4-cm radius on one end and a 90° angle on the other end.

Ces deux références, **030** et **040**, se terminent à l'une des extrémités par un angle droit de 90°, et à l'autre extrémité par une courbure d'un rayon de 4 cm.

food and floor the kit chen

**indu
gres**

**100%
Biostop**



La solución más limpia para la cocina industrial

Indugres 100% acabado biostop elimina las bacterias y garantiza la autoprotección de toda la superficie de gres porcelánico más la junta de colocación

Funciona 24 h en interiores y exteriores

Funciona con luz artificial, con luz natural y en completa oscuridad.

Autoprotección total y permanente

La acción auto protectora es permanente y 100% segura. No necesita ningún tratamiento posterior ni mantenimiento para funcionar.

Eficacia probada contra las bacterias

Evita al 100% la proliferación de bacterias como: **Staphylococcus Aureus, Escherichia Coli, Proteus Vulgaris, Salmonella typhi, Enterococcus Faecalis, Streptococcus Pyogenes, Bacillus o Listeria Monocytogenes**

Es gres porcelánico industrial Rosa gres de alta calidad

Su proceso de fabricación garantiza que todas las propiedades del gres porcelánico industrial Rosa Gres se mantienen intactas.

No es tóxico para la salud

Es totalmente inocuo para la salud humana.

Reduce los olores

Evita los malos olores que pueda provocar los depósitos de microorganismos en las superficies.

The cleanest solution for commercial kitchens

Indugres 100% Biostop eliminates bacteria and guarantees self-protection of the entire porcelain stoneware surface including the grout joint.

Works 24 hours indoors and outdoors.

Works in artificial light, natural light and total darkness.

Total and permanent self-protection.

Self-protection is permanent and 100% safe. It does not require any treatment or maintenance.

Proven efficacy against bacteria.

Prevents 100% of bacteria growth such as: **Staphylococcus Aureus, Escherichia Coli, Proteus Vulgaris, Salmonella Typhi, Enterococcus Faecalis, Streptococcus Pyogenes, Bacillus and Listeria Monocytogenes.**

Rosa Gres high-quality industrial porcelain stoneware. The manufacturing process guarantees that all the properties of Rosa Gres industrial porcelain stoneware are maintained.

Not toxic to health.

Completely harmless to human health.

Reduces odors.

Prevents unpleasant odors caused by the accumulation of microorganisms on surfaces.

La solution la plus propre pour les cuisines industrielles

La finition 100% biostop d'Indugres élimine les bactéries et garantit l'autoprotection de toute la surface du grès cérame ainsi que du joint entre les carreaux

Fonctionne 24 heures à l'intérieur et à l'extérieur

Il Fonctionne à la lumière artificielle, à la lumière naturelle et dans l'obscurité totale.

Auto-protection totale et permanente

L'action auto-protectrice est permanente et sûre à 100%. Aucun post-traitement ou entretien n'est nécessaire pour fonctionner.

Efficacité prouvée contre les bactéries

Évite à 100% la prolifération de bactéries telles que : **Staphylococcus aureus, Escherichia coli, Proteus Vulgaris, Salmonella Typhi, Enterococcus faecalis, Streptococcus pyogenes, Bacillus, Listeria monocytogenes**

Grès cérame porcelaine industriel de haute qualité

Son processus de fabrication garantit que toutes les propriétés du grès cérame industriel Rosa Gres restent intactes.

Non toxique pour la santé

Totalement inoffensif pour la santé.

Réduit les odeurs

Évite les odeurs désagréables causées par les dépôts de microorganismes sur les surfaces.



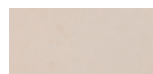

122 G3
11,9 x 24,4 x 1
Indubeige R9



240 G3
24,4 x 24,4 x 1
Indubeige R10

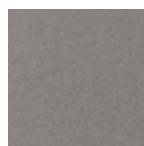

240 G3
24,4 x 24,4 x 1
Indugrey R10

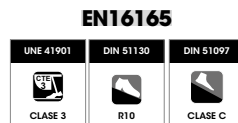

240 G3
24,4 x 24,4 x 1
Indubeige R12

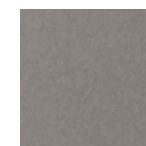
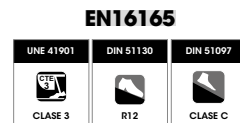

240 G3
24,4 x 24,4 x 1
Indugrey R12

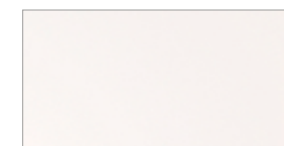
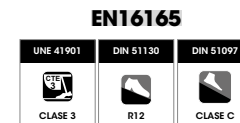

244 G1
24,4 x 49,4 x 0,8
Bio White Liso



Bio-Cerpoxi Blanco
21 KG/U

Bio-Cerpoxi Gris
21 KG/U

Junta de colocación
100% Biostop

Mortero coloreado epoxi con resistencia al ataque de los ácidos y propiedades protectoras: previene el crecimiento de microorganismos perjudiciales para la salud.

Grout Joints
100% Biostop

Coloured epoxy resin resistant to acid and with protective properties: prevents the growth of harmful microorganisms.

Mortier de Jointoiment
100% Biostop

Mortier coloré époxy résistant aux agressions acides et présentant des propriétés protectrices pour empêcher le développement de microorganismes nocifs pour la santé.



Medias cañas | Half round pieces | Demi-Cannes

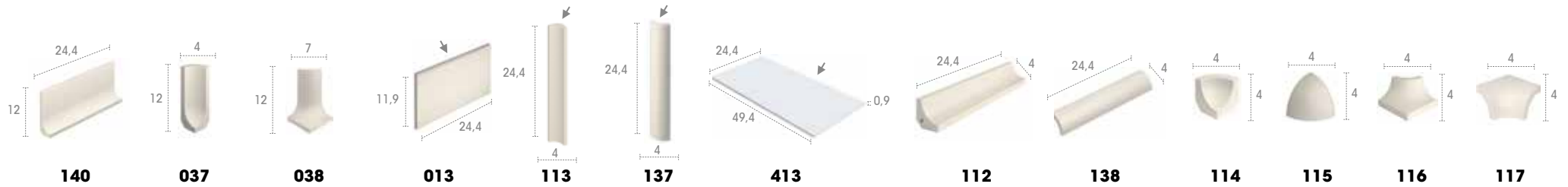
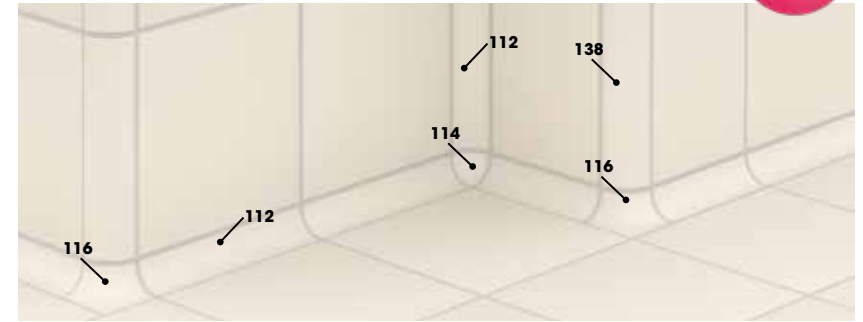
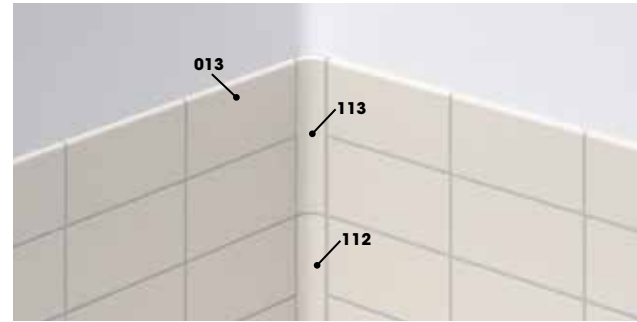
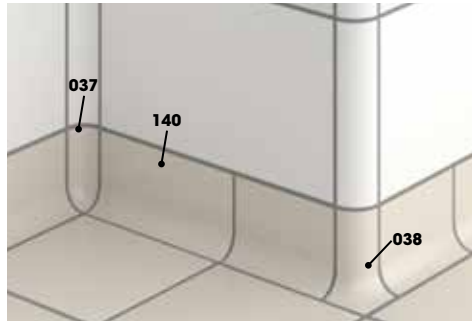

Canaletas | Shallow Chanel | Goulottes

Ducha | Shower | Douche

Peldaños | Peldaños | Peldaños

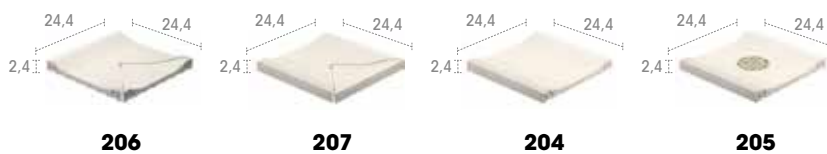
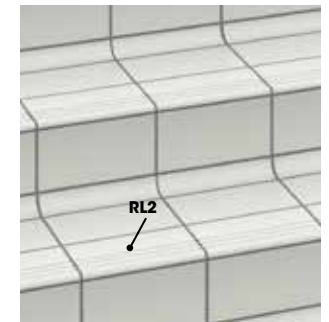
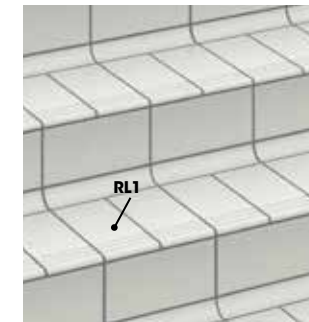
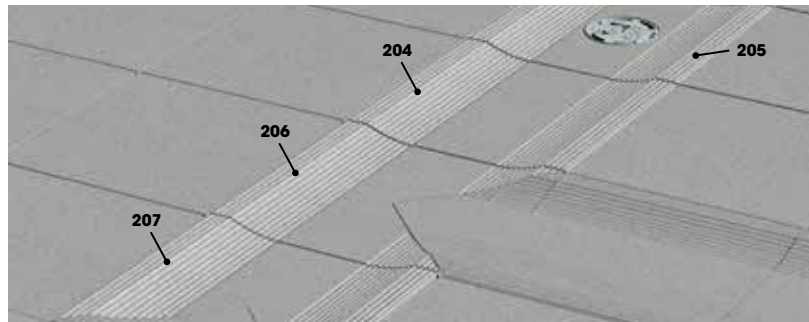

we are eco frien dly



NUEVA CUBIERTA SOLAR

Instalación fotovoltaica para el autoconsumo eléctrico

NEW SOLAR ROOF

Photovoltaic system for self-consumption of electricity

NOUVEAU TOIT SOLAIRE

Installation photovoltaïque pour autoconsommation électrique

9.435 m²

2.000 Kwp

2.721.099 kwh

ANO
YEAR
ANNÉE

PROYECTO ZERO NUESTRO COMPROMISO CON EL MEDIO AMBIENTE

El compromiso de **Rosa Gres** por generar el mínimo impacto medioambiental nos llevó a crear un protocolo de Sostenibilidad propio. Es nuestro **Proyecto ZERO** y se basa en los siguientes propósitos:

- Practicar una mejora continuada, de forma transversal en toda la empresa, conscientes del futuro a corto y largo plazo.
- Producir de forma eficiente y controlada para reducir el consumo de recursos naturales.
- No generar residuos durante el proceso de producción: separar, reutilizar, valorizar.
- Prever y controlar el impacto medioambiental del producto **Rosa Gres** una vez acabado: su traslado desde la fábrica, su vida útil y su reciclaje final.

PROGRAMAS PROYECTO ZERO

Zero Vertidos

Reutilizamos el 100% del agua del proceso productivo.

Zero Residuos

Segregamos y reciclamos el 100% de los residuos valorizables.

Reciclaje Non-Stop

Procesamos todos los materiales del ciclo de producción para su reutilización.

Zero Emisiones

- Toda la potencia eléctrica que consume Rosa Gres es de origen renovable. Además se han instalado placas fotovoltaicas en la cubierta de la planta, que generan 2 MW para autoconsumo.
- Optimización mediante el control y gestión on-line de los recursos energéticos.

Construcción industrializada. Ecodiseño

Diseñamos sistemas constructivos que minimizan el residuo en la obra, reducen el tiempo de ejecución y aseguran el resultado final.

CERTIFICACIONES MEDIOAMBIENTALES

Rosa Gres formó parte del comité de desarrollo de la normativa **DAPc®**, la nueva Ecoetiqueta europea de tipo III que permite evaluar el impacto ambiental a lo largo del ciclo de vida del producto y su proceso de fabricación.

La utilización de productos cerámicos, sistemas de construcción y sistemas de colocación **Rosa Gres** aporta puntos para los certificadores LEED, Verde, Breeam y otros.

Rosa Gres es miembro del **GBCe** desde junio de 2010.

PROJECT ZERO OUR COMMITMENT TO THE ENVIRONMENT

Rosa Gres' commitment to minimizing our environmental impact has led us to create our own sustainability protocol, known as **Project ZERO**, which is based on the following objectives:

- Ensure continuous improvement throughout the company, taking into account short and long-term plans.
- Manufacture in an efficient and controlled manner to reduce the consumption of natural resources.
- Avoid waste in the production process by separating, reusing and recycling.
- Anticipate and control the environmental impact of the **Rosa Gres** product once it is finished, including its transfer from the factory, its life span and its final recycling.

PROJECT ZERO PROGRAMS

Zero Water Discharge

We recycle 100% of the water used in the production process.

Zero Waste

We separate and recycle 100% of the recyclable waste.

Non-Stop Recycling

We recycle all materials in the production cycle.

Zero Emissions

- All the electricity used by Rosa Gres comes from renewable sources. In addition, photovoltaic panels have been installed on the roof of the plant, generating 2 MW of self-consumption.
- Optimization through online control and management of energy resources.

Industrialized construction. Ecodesign

We design construction systems that minimize waste during the construction process, reduce execution time and guarantee the final result.

ENVIRONMENTAL CERTIFICATIONS

Rosa Gres was part of the development committee of the **DAPc®** standard, the new European Type III eco-label, which allows us to evaluate environmental impact throughout the life cycle of the product and the manufacturing process.

The use of **Rosa Gres** porcelain stoneware products, construction systems and installation systems can earn points for LEED, Verde, Breeam and other certifiers.

Rosa Gres has been a member of the **GBCe** since June 2010.

PROJET ZÉRO NOTRE ENGAGEMENT POUR L'ENVIRONNEMENT

L'engagement de **Rosa Gres** à générer un impact minimum sur l'environnement nous a conduits à créer notre propre protocole de durabilité. Il s'agit de notre **Projet ZERO** qui se base sur les objectifs suivants :

- Assurer une amélioration continue, de manière transversale, au sein de toute l'entreprise, en étant conscients du futur à court et à long terme.
- Produire de manière efficace et contrôlée afin de réduire la consommation de ressources naturelles.
- Ne pas générer de déchets au cours du processus de production : séparer, réutiliser, valoriser.
- Anticiper et contrôler l'impact environnemental du produit **Rosa Gres** une fois terminé : son transfert depuis l'usine, sa durée de vie et son recyclage en fin de vie.

PROGRAMMES PROJET ZÉRO

Zéro Eau Déversée

Nous recyclons 100% de l'eau utilisée pendant la production.

Zéro Déchet

Nous séparons et recyclons 100% des déchets récupérables.

Recyclage Non-Stop

Nous utilisons tous les matériels du cycle de production en vue de les réutiliser.

Zéro Émission

- Toute l'énergie électrique consommée par Rosa Gres provient de sources renouvelables. De plus, des panneaux photovoltaïques ont été installés sur le toit de l'usine, produisant 2 MW pour l'autoconsommation.

- Optimisation grâce au contrôle et à la gestion en ligne des ressources énergétiques.

Construction industrialisée. Écoconception

Nous concevons des systèmes de construction qui minimisent les déchets sur le chantier, réduisent le temps d'exécution et garantissent le résultat final.

CERTIFICATIONS ENVIRONNEMENTALES

Rosa Gres a fait partie du comité de développement de la norme **DAPc®**, le nouveau label écologique européen de type III qui permet d'évaluer l'impact environnemental tout au long du cycle de vie du produit et de son processus de fabrication.

L'utilisation des produits céramiques, des systèmes de construction et d'installation de **Rosa Gres** permet d'obtenir des points pour les certifications LEED, Verde, Breeam et autres.

Rosa Gres est membre du **GBCe** depuis juin 2010.

Projects



LUXURY				HOTEL SPA	URBAN
	Golden Crown Nazareth Hotel, Vladislavova, Israel	Elba Royal Village Resort, Lanzarote, Canary Islands, Spain		Sandos Playacar, Playa del Carmen, México	
Gran Hotel Miramar, Málaga, Spain	Amman Marriot Hotel, Amman, Jordan	Princess Inspire, Tenerife, Canary Islands, Spain.		Royal Uno Resort & Spa, Cancún, México	Aqua Hotel Silhouette & Spa, Malgrat de Mar, Barcelona, Spain
Meliá Sierra Nevada, Granada, Spain	Intercontinental Amman, Amman, Jordan	Pine Cliffs Resort Algarve, Albufeira, Portugal		Secrets Playa Mujeres Golf & Spa Resort, Cancún, México	Spa Hotel Attica 21, Vigo, Spain
Hotel Kimpton Aysla, Palma de Mallorca, Balearic Islands, Spain	The Ritz-Carlton, Montreal, Canada	Hotel Sheraton Cascais Resort, Cascais, Portugal		Dreams Playa Mujeres Golf & Spa Resort, Quintana Roo, México	Le Petit Beaumarchais, París, France
Ibiza Bay, Ibiza, Balearic Islands, Spain	Iberostar Grand Hotel Packard, La Habana, Cuba	JW Marriot Venice Resort & Spa, Venice, Italy		Meliá Paradisus los Cayos, Cayo Santa Maria, Cuba	Spa Naantali, Naantali, Finland
Hotel Royal Marine suits Lanzarote, Canary Islands, Spain	Hotel Radisson Royal, Panama City, Panama	Odyssee Resort Thalasso and Spa Oriental, Zarzis, Tunisia		Paradisus Varadero Resort & Spa, Varadero, Cuba	Hotel Europa Fit, Hévíz, Hungary
Lango Design Hotel & Spa, Kos, Greece	Hyatt Centric, Guatemala City, Guatemala	Tui Blue Oceana Suites, Hammamet, Tunisia		Valentín Varadero El Patriarca, Varadero, Cuba	Hotel Horal Wellness & Spa Hotel, Radhoštská, Czech Republic
Theros All Suit Hotel, Kos, Greece	El Cielo Hotel, Medellín, Colombia	TMK Hotel Flora Park Hammamet, Tunisia		Hotel Memories Miramar Habana, La Habana, Cuba	Spa Hotel Svoboda, Mariánské Lázně, Czech Republic
Galgorm Resort and Spa, Galgorm, United Kingdom	The Fives Ocean Front Puerto Morelos, Puerto Morelos, México	Hilton Rijeka Costabella, Beach Resort & Spa, Rijeka, Croatia		Iberostar Playa Pilar, Cayo Guillermo, Cuba	Hotel Mara Sinaia, Sinaia, Romania
Residence Inn by Marriott, Amsterdam, The Netherlands	THEME HOTEL	Kanika Hotels & Resorts, Limassol, Cyprus		RURAL	RINA Hotel, Sinaia, Romania
The Marmorosch, Bucharest, Romania	The WB Abu Dhabi, Curio Collection by Hilton, Abu Dhabi, EAU	Amavi Hotel, Paphos, Cyprus		Casa Rural Boutique Palacio Condes de Cirac, La Rioja, Spain	Hotel Horizont Resort, Stará Lesná, Slovakia
Kharkiv Palace Hotel, Kyiv, Ukraine	Costa Caribe Aquatic Park - Port Aventura, Tarragona, Spain	Hotel Meliá Durres, Gjiri, Albania		Parador Nacional Costa da Morte, Muxía, A Coruña, Spain	Hotel Impozant Valcianska Dolina, Valča, Slovakia
Spa Hotel Villa Ivanovi Dvori, Bićine, Croatia	RESORT	Orea Resort Santon, Brno-Bystrc, Czech Republic.		Hotel Pazo O Rial, Villagarcía de Arousa, Pontevedra, Spain	Hotel Termal Vyhne, Vyhne, Slovakia
Hilton Malta Hotel, St Julian's, Malt	Barceló Costa Ballena Golf & Spa, Cádiz, Spain	Complex Hotelier Steaua de Mare, Eforie Nord, Romania		Panoráma Hotel, Štrba, Slovakia	Terme Olimia D.D., Podčetrtek, Slovenia
Six Senses Kaplankaya, Bodrum, Turkey	Barceló Montecastillo Golf, Jerez de la Frontera, Spain	Royalton Grenada, Saint George, Grenada		Hotel Rozsutek, Terchová, Slovakia	SPA Orkana, Lublin, Poland
Hotel Sun Bat Yam, Bat Yam, Israel	Barceló Punta Umbría Beach Resort, Punta Umbría, Spain	Mamula Island Hotel, Mamula Island, Montenegro		Resort Sobotín, Sobotín, Czech Republic	Uvildy Resort, Karabash, Russia
The Jaffa, Luxury Collection Tel Aviv, Israel	St. Regis Mardavall Mallorca Resort, Palma de Mallorca, Balearic Islands, Spain	Lopesan Costa Bávaro Resort, Spa & Casino, Punta Cana, Dominican Republic		Hotel Grand Kopaonik, Kopaonik, Serbia	
					CAMPING
					Camping & Resort Sangulí, Salou, Tarragona, Spain
					Camping La Plage, Argelès-sur-Mer, France

NORMA DE ENSAYO / TESTING STANDARD / NORME D'ESSAI			REGULACIÓN / REGULATION / RÉGLEMENTATION EN 14411 - ISO 13006		Rosa Gres
	ISO 10545 - 2	Características dimensionales Dimensions and surface quality Dimensions et aspect de la surface	Exigida Required Exigée		Garantizada Guaranteed Garantie
	ISO 10545 - 3	Absorción de agua Water absorption Absorption d'eau	Grupo B1a Grupo A1a E ≤ 0,5 %		E ≤ 0,5 %
	ISO 10545 - 4	Fuerza de rotura Breaking strength Effort à la rupture	≥ 1.300 N		≥ 1.300 N
		Resistencia a la flexión Modulus of rupture Résistance à la flexion	≥ 35 N/mm ²		≥ 35 N/mm ²
	ISO 10545 - 9	Resistencia al choque térmico Thermal shock resistance Résistance aux chocs thermiques	Exigida Required Exigée		Garantizada Guaranteed Garantie
	ISO 10545 - 12	Resistencia a la helada Frost resistance Résistance au gel	Exigida Required Exigée		Garantizada Guaranteed Garantie
	ISO 10545 - 13	Resistencia química ⁽¹⁾ Chemical resistance ⁽¹⁾ Résistance chimique ⁽¹⁾	Min. Clase B		A LA HA
	ISO 10545 - 14	Resistencia a las manchas Stain resistance Résistance aux tâches	Min. Clase 3		Garantizada Guaranteed Garantie

⁽¹⁾ Excepto ácido fluorhídrico y sus compuestos | Except hydrofluoric acid and its components | A l'exception de l'acide fluorhydrique et ses composés
Piezas base: grupo B1a | Field tiles: grupo B1a | Pièces de base: grupo B1a
Piezas especiales: grupo A1a | Trim pieces: grupo A1a | Pièces spéciales: grupo A1a

SEGURIDAD / SAFETY / SÉCURITÉ

COEFICIENTES DE ANTIDESLIZAMIENTO / NON-SLIP COEFFICIENTS / COEFFICIENTS DE RÉSISTANCE			LISO / SMOOTH FINISH / FINITIONS LISSES		ANTIDESLIZANTE / ANTI-SLIP FINISH / FINITIONS ANTIDÉRAPANTE	
	EN 16165 Anexo A (DIN 51097)	Norma para pie desnudo Norm for barefoot traffic areas Norme pour pieds nus	-		Clase C ≥ 24°	Alma - Iconic - Mistery - Mythos Pietro - Serena - Stela - Trésor
	EN 16165 Anexo B (DIN 51130)	Norma para pie calzado Norm for footwear traffic areas Norme pour pieds chaussés	R9 ≥ 6° - <10°	Alma - Iconic Mistery - Mythos Stela	R10 > 10° - 19°	Trésor
					R11 > 19° - 27°	Alma - Iconic - Mistery - Mythos Pietro - Serena - Stela
	EN 16165 Anexo C (UNE 41901)	Pendulum Test	Clase 1 15 < Rd ≤ 35	Alma - Iconic Mistery - Stela Mythos	Clase 3 Rd > 45	Alma - Iconic - Mistery - Mythos Pietro - Serena - Stela - Trésor
ANSI A326.3		Coefficiente de fricción Coefficient of friction Coefficient de friction	-		Exterior wet ≥ 0,55	Alma - Iconic - Mistery - Mythos Pietro - Serena - Stela - Trésor



Portada y contraportada | Cover and back cover | Couverture et quatrième de couverture: **Kimpton Aysla Mallorca. IHG, Hotels & Resorts. Santa Ponsa, Calvià, Mallorca, Balearic Islands, Spain**



Rosa Gres, SLU

Oficina Central - Central office - Bureau Central

Ctra. Sant Cugat, km. 3

08290 Cerdanyola, Barcelona, Spain

Tel. + 34 93 586 30 60

Ventas: + 34 93 586 37 00

Export Sales: + 34 93 586 37 02

info@rosagres.com

www.rosagres.com

Rosa Gres France, SARL

64140 Lons, France

Tel. + 00 33 411 92 00 30

contact@rosagres.com

administration@rosagres.com

www.rosagres.com/fr

Fábrica - Factory - Fabrique

Pol. Ind. Mas Vell

Ramón Sugrañes, 1

43144 Vallmoll, Tarragona, Spain

Mayo 2023

